

nicos international

vasche | baths

lavabi | washbasins

piatti doccia | shower trays

COLLECTIONS

PREVIEW SICAM 2024

**We anticipate and develop
market trends in collaboration
with the most innovative brands
of bathroom furniture and
sanitary ware.**

pensare in modo logico. think logic.

Siamo leader europei OEM nello sviluppo e nella produzione di prodotti in solid surface e marmoresina e siamo riconosciuti in tutto il mondo per la nostra qualità.

We are the OEM European leader in the development and production of solid surface and cast marble products, and we are recognised worldwide for quality.



gruppo industriale. industrial group.

Azienda OEM per B2B

Siamo leader europei nello sviluppo e nella produzione di prodotti in solid surface e marmoresina. Siamo riconosciuti in tutto il mondo per le forniture OEM (Original Equipment Manufacturer) di alta qualità. Operiamo nel B2B, approvvigionandoci di materiali di altissima qualità per produrre lavabi, piatti doccia e vasche da bagno per i nostri partner che cercano prodotti standard, su misura e private label/custom. In 20 anni siamo cresciuti in risposta agli sviluppi del mercato dell'arredo bagno, aprendo linee di produzione di nuova generazione, ampliando la nostra offerta e migliorando il nostro posizionamento logistico in tutta Europa.

OEM company for B2B

We are the European leader in the development and production of solid surface and cast marble products. We are recognised worldwide for high quality OEM (Original Equipment Manufacturer) supply. We operate in B2B, sourcing the highest quality materials to create washbasins, shower trays and baths for our partners seeking standard, bespoke and private label products. Over 20 years we have grown in response to developments in the bathroom furniture market, opening new generation production lines, expanding our offer and improving our logistical positioning across Europe.

Capacità produttiva annuale

Continuiamo ad investire risorse significative in automazione, robotica, software e logistica per gestire al meglio il mercato.

Annual production capacity

We continue to invest significant resources in automation, robotics, software and logistics to better manage the market.

Nicos International Unit 1
Portobuffolè - Italy
16.400 mq | sqm

Nicos International Unit 2
Prata di Pordenone - Italy
20.000 mq | sqm

Bulsan
Botevgrad - Bulgaria
18.600 mq | sqm

CAPACITÀ PRODUTTIVA ANNUALE 500.000 PRODOTTI ALL'ANNO

ANNUAL PRODUCTION CAPACITY 500.000 PRODUCTS PER YEAR



225.000
lavabi un anno
washbasins a year

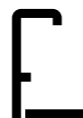

250.000
piatti doccia all'anno
shower trays a year



25.000
vasche da bagno all'anno
bathtubs a year

L'azienda dispone di 3 stabilimenti produttivi e 2 siti logistici in Italia e Spagna per un totale di 55.000 mq.

The group includes 3 production plants and 2 logistics sites in Italy and Spain in a total of 55.000 sqm.



Unit 1: Nicos International Portobuffolè - Sede e sito produttivo di marmoresina 16.400 mq
Nicos International Portobuffolè unit - Headquarter and cast marble factory 16.400 sqm



Unit 1: Nicos International Prata di Pordenone - Centro logistico e sito produttivo di superfici solide 20.000 mq
Nicos International Prata di Pordenone unit - Logistic center and solid surface factory 20.000 sqm



Bulsan Botevgrad Bulgaria - Sito produttivo di marmoresina 18.600 mq
Bulsan Botevgrad Bulgaria - Cast marble factory 18.600 sqm

la nostra storia. our history.

Crescita costante nel mondo dell'arredo bagno

Constant growth in the world of bathroom furniture

- | | | |
|-------------|--|---|
| 2000 | Il Gruppo Europak acquista Nicos, specializzata nella realizzazione di componenti in poliuretano, e crea la nuova società Nicos International Spa. | The Europak Group acquires Nicos International, specialising in the manufacture of polyurethane components and creates the new company, Nicos International International Spa. |
| 2003 | Viene aperta la sede di Portobuffolè di 16.400 m ² (Unit 1). | Nicos International moves in the new headquarters of 16,400 sqm. |
| 2004 | La proprietà assume nuovi manager per creare un team giovane ed innovativo. | The property hires new managers to create a young and innovative team. |
| 2005 | Viene inaugurata in Bulgaria la Bulsan, una fabbrica di 9.000 m ² per la produzione di 50.000 lavabi all'anno in Mineralmarmo lucido. | Bulsan is inaugurated in Bulgaria, a 9,000 sqm factory for the production of 50,000 Mineralmarmo® washbasins per year. |
| 2007 | La superficie di Bulsan è raddoppiata, passando da 9.000 a 18.000 m ² . | Bulsan's surface area is doubled from 9,000 to 18,600 sqm. |
| 2008 | Nello stabilimento di Portobuffolè (Unit 1) viene aperta la linea produttiva di lavabi su misura in solid surface. | In the Portobuffolè plant the production line of custom-made solid surface washbasins is opens. |
| 2009 | In Bulsan, la capacità produttiva di lavabi su misura viene ulteriormente aumentata di 50.000 pezzi. | In Bulsan, the production capacity of custom-made washbasins is further increased by 50,000 pcs. |
| 2010 | Vengono realizzate le prime linee di lavabi standard in Mineralmarmo (Easy, Step, Quadro). | The first lines of standard washbasins in Mineralmarmo® (Easy, Step, Quadro) are open. |
| 2011 | La capacità produttiva di Bulsan viene portata ad un totale 150.000 lavabi all'anno, inserendo anche il Mineralmarmo in finitura opaca. | Bulsan's production capacity is increased to a total of 150,000 washbasins per year, including Mineralmarmo® in a matt finish. |
| 2012 | Viene aperta la prima filiale logistica spagnola a Barcellona. | Bulsan opens new Spanish warehouse in Barcelona. |
| 2013 | Vengono presentate al mercato europeo nuove linee di lavabi standard (Easy, Plano, Zen, Cosmos, Minima, Skin). | New lines of standard washbasins (Easy, Plano, Zen, Cosmos, Minima, Skin) are presented to the European market. |
| 2014 | In Bulsan vengono realizzate le prime 2 linee standard di piatti doccia (Pietra e Liscio). | Bulsan starts to produce new standard shower trays. |
| 2015 | Reshoring della linea di piatti doccia dalla bulgara Bulsan allo stabilimento italiano di Portobuffolè (Unit 1), con un nuovo impianto di produzione automatizzato. | Reshoring of the shower tray line from Bulsan in Bulgaria to the Italian plant in Portobuffolè, with a new automated production plant. |
| 2016 | A Portobuffolè (Unit 1) viene completato l'impianto automatizzato e realizzato il magazzino verticale automatico per 7.000 piatti doccia. | In Portobuffolè the automated system is completed and the automatic vertical warehouse for 7,000 shower trays is built. |
| 2017 | Viene aperto il nuovo stabilimento di 14.000 m ² a Prata di Pordenone (Unit 2), utilizzato come centro logistico. | Nicos International opens in Prata di Pordenone (solid surface factory) of 14,000 sqm. |
| 2018 | Lo stabilimento di Prata di Pordenone (Unit 2) viene ampliato a 20.000 m ² per ospitare le nuove linee di produzione dei prodotti in solid surface. Nel 2018 è l'anno della fondazione della Top Custom International, in società con la famiglia Castagnari. | The Prata di Pordenone plant is expanded to 20,000 sqm to accommodate new production lines for solid surface products. |
| 2019 | Avviamento della seconda linea di produzione di piatti doccia a Portobuffolè (Unit 1) per una capacità produttiva annua di 150.000 pezzi
Avviamento di una nuova linea di produzione per lavabi e vasche da bagno in solid surface a Prata di Pordenone (Unit 2). | Start-up of a second shower tray production line in Portobuffolè with an annual production capacity of 150,000 pcs.
Start-up of a new production line for solid surface washbasins and bathtubs in Prata di Pordenone. |
| 2022 | Avviamento di una nuova linea di produzione per lavabi in cast marble per una capacità produttiva annua di 200.000 pezzi. | Start-up of a new production line for cast marble washbasins with an annual production capacity of 120,000 pcs. |
| 2024 | Messa in funzione di una nuova linea produttiva di lavabi "su misura" in solidsurface per una capacità produttiva annua di 37.000 pezzi. | Start up of a new production line for bespoke basins in solidsurface with an annual production capacity of 37,000 pieces. |



proposte. proposals.



Prodotti B2B standard

Abbiamo un'ampia gamma di piatti doccia, lavabi e vasche da bagno, tutti personalizzabili per dimensioni, finiture e colori. Lavoriamo esclusivamente nel settore B2B e la nostra esperienza nel solid surface e nel marmoresina, è il miglior supporto per i nostri clienti.

Standard B2B products

We have a wide range of shower trays, wash basins and baths, all customizable in size, finish and colours. We work exclusively in the B2B sector, and our experience in solid surface and cast marble, for which we are European leaders, is the best support for our customers.



Prodotti customizzati

Per le aziende di arredo bagno e i più famosi marchi internazionali, realizziamo prodotti con materiali propri sviluppando stampi su misura, garantendo ai partner che si affidano a noi il giusto lotto minimo.

Bespoke products

For bathroom furniture companies and most famous international brands, we manufacture products with our own materials developing bespoke moulds, guaranteeing partners who rely on us the right minimum lot.



Private label

La nostra esperienza OEM comprende la produzione di piatti doccia, vasche da bagno e lavabi che produciamo anche per il segmento Private Label, per partner di tutto il mondo. Il know-how dei nostri laboratori e del nostro ufficio tecnico è a disposizione per qualsiasi richiesta.

Private label

Our OEM expertise includes the manufacture of shower trays, bathtubs and washbasins, which we also produce for the Private Label segment, for partners around the world. The know-how of our laboratories and our technical department is available for any request.

flessibilità di personalizzazione. flexibility to customise.

Nicos International offre la possibilità di brandizzare i prodotti a più livelli.

Nicos International offers the option of brand products to different levels.

Opzioni di branding Branding options



Packaging dedicati Customized packaging

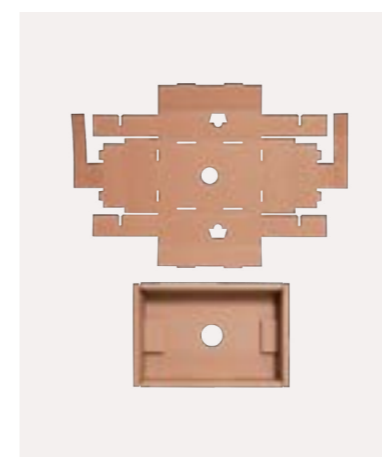

Colori & textures Colours & textures



Etichette Labels



Accessori Accessories



Istruzioni Instructions



sostenibilità ambientale. environmental sustainability.



Nicos è sensibile alle tematiche della sostenibilità e ha avviato un percorso di sensibilizzazione e miglioramento continuo sui diversi vettori energetici coinvolti nella sua produzione e sugli effetti che questi hanno sui principali indicatori di impatto ambientale come il Total Global Warming Potential (GWP). Grazie all'analisi EPD "Cradle to Gate" condotta sui suoi impianti produttivi, è emerso che un deficit iniziale legato al prodotto di sintesi viene completamente eliminato quando lavoriamo a temperatura ambiente, minimizziamo gli scarti e riutilizzandoli per i sottofondi stradali. Anche nelle produzioni del marmoresina l'impiego di energia elettrica e termica è oltre il 90% meno impattante rispetto a un analogo prodotto ceramico.

Comprendere l'importanza della vita è il primo passo per comprendere il nostro ruolo e la nostra responsabilità.

È fondamentale onorare chi ci ha preceduto e chi verrà dopo di noi.

Sfruttando i pensieri strategici determinati dal COVID19, abbiamo deciso di accelerare e di mettere la sostenibilità ambientale al centro della nostra strategia, per un pianeta migliore da lasciare alle nuove generazioni.

Nicos is sensitive to sustainability issues and has begun a process of awareness and continuous improvement on the various energy vectors involved in its production and on the effects these have on the main environmental impact indicators such as the Total Global Warming Potential (GWP). Due to the "Cradle to Gate" EPD analysis conducted on its production plants, it emerged that an initial deficit linked to the synthetic product is completely eliminated when we process at room temperature, minimize waste, reuse of waste for road surface foundations. Even in cast marble productions, the use of electrical and thermal energy is over 90% less impactful than a similar ceramic product.

Understanding the importance of life is the first step in understanding our role and responsibility. It is essential to honour those who preceded us and who will come after us.

Taking advantage of the strategic thoughts determined by COVID19, we decided to accelerate and placed environmental sustainability at the centre of our strategy, for a better planet to leave to the new generations.

produciamo energia pulita. we produce clean energy.



PRODUCIAMO ENERGIA PULITA

Gestiamo l'aria calda, generata dai compressori, in modo da riscaldare l'acqua che serve agli impianti tecnici, e che riutilizziamo anche per l'alimentazione dei forni, risparmiando molta energia. Inoltre, nel gennaio 2020, abbiamo installato un impianto fotovoltaico da 73,080 kWp, con una produzione annuale di 79.657 kWh (1.090 kWh/kWp), pari ad un abbattimento annuale di 55,8 tonnellate di CO₂. La produzione di piatti e lavabi in cast marble di Portobuffolè contiene l'8% degli scarti di produzione interna, che vengono pertanto riciclati al 90%.

We manage hot air, generated by the compressors, to heat water needed for our technical systems, and which we also reuse to power the ovens, thus conserving of energy.

Furthermore, in January 2020, we installed a 73,080 kWp photovoltaic system, with an annual production of 79,657 kWh (1,090 kWh/kWp), equal to an annual reduction of 55,8 tons of CO₂. The production of shower trays and washbasins in cast marble at Portobuffolè contains 8% of internal production waste, 90% of which is then recycled.



73,080 kWp

sistema fotovoltaico
photovoltaic system

79,657 kWp

produzione annuale
annual production



- 55,8 tons of CO₂

riduzione annuale
annual reduction

utilizziamo resine Biobased® e plastica riciclata. we use Biobased® resins and recycled plastic.

RIUTILIZZIAMO PLASTICA RICICLATA

Abbiamo scelto di salvare il pianeta concretamente: oltre ad essere l'unica azienda al mondo a produrre materiali Biobased®, inoltre possiamo anche offrire la possibilità di produrre lavabi in cast marble con resine contenenti anche PET riciclato.

Tutti possono aiutare a salvaguardare la salute del pianeta cercando di allungare il ciclo di vita della plastica, evitando di gettarla dopo un singolo utilizzo e riciclando correttamente i rifiuti. Noi, come azienda, sperimentiamo nuove tecnologie innovative in grado di valorizzare il riciclo, ottimizzando i processi e creando alternative possibili alla salvaguardia dell'ambiente.

We have chosen to help save the planet in a tangible way: in addition to being the only company in the world to produce Biobased® resins, we have also chosen to reuse a minimum part of PET plastic bottles which, through a process of fragmentation and purification, become a component in the formulation of our resins. We utilize this resin to produce washbasins and shower trays.

We can all help safeguard the health of our planet by trying to extend the life cycle of plastic, avoiding throwing it after a single use and correctly recycling waste. We, as a company, experiment with new innovative technologies to enhance recycling, optimising processes and using viable alternatives to protect the environment.

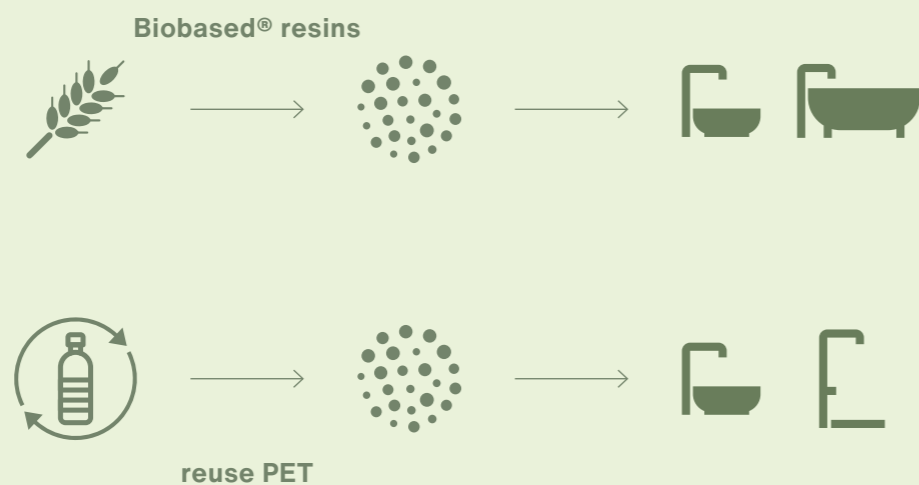

pensare in modo ecologico. think green.



ARIA:

nel 2012 i nostri materiali hanno ricevuto la certificazione internazionale Green Guard Gold relativa alle emissioni di composti organici volatili in ambienti chiusi, contribuendo alla valutazione della certificazione LEED. I dati e la successiva certificazione vengono esaminati annualmente da un laboratorio terzo.

AIR:

in 2012 our materials received the international Green Guard Gold certification relating to emissions of volatile organic compounds in closed environments, contributing to the LEED certification rating. The data and subsequent certification are reviewed annually by a third-party laboratory.



RICICLO:

il 50% dei materiali di scarto di produzione viene riciclato, l'8% del peso del materiale di un piatto doccia viene riciclato.

RECYCLE:

50% of production waste materials are recycled, 8% of a shower tray's internal material weight is recycled.



RIFIUTI:

il 95% dei rifiuti prodotti negli stabilimenti Nicos viene recuperato in altre filiere produttive.

WASTE:

95% of waste produced in Nicos' plants is recovered in other manufacturing chains.



ACQUA:

i lavaggi ad acqua sono stati sostituiti con metodi di lavaggio a secco e le macchine hanno sistemi di raffreddamento con cicli d'acqua chiusi.

WATER:

water washes have been replaced with dry cleaning methods and the machines have cooling systems with closed water cycles.



ENERGIA:

il 24,4% dell'elettricità utilizzata deriva da fonti rinnovabili. Per 1 kg di prodotto si ha un consumo equivalente di 0,18 kg di CO₂ da combustibili fossili.

ENERGY:

24.4% of the electricity used is derived from renewable sources. For 1kg of product there is an equivalent consumption of 0.18kg CO₂ from fossil fuel.



MATERIALI:

dal 2020 il solid surface viene prodotto con resine da colture organiche a rapido rinnovamento evitando di utilizzare di quelle di origine fossile.

MATERIALS:

from 2020 solid surface material is produced with resins from organic, rapidly renewing cultures, and not from fossil origin.



sviluppo di imballaggi sostenibili
= cartone al posto del polistirolo

development of sustainable packaging
= cardboard vs polystyrene



72.850 kWh da fonti rinnovabili pari a 47.353 kg CO₂ risparmiati all'anno

72,850 kWh from renewable sources equal to 47,353 kg CO₂ saved at year



cicli di produzione a freddo

cold production cycles



recupero dell'energia termica in eccesso per alimentare i forni di produzione

recovery of excess thermal energy to supply production ovens

16 vasche / bathtubs

- 20 siracusa
- 22 loop
- 24 soft
- 28 bridge
- 30 round
- 32 penny
- 36 grace & solar
- 38 mood
- 40 evolution
- 44 krizia
- 46 amalfi
- 48 wave
- 52 ibiza
- 54 bold
- 56 portofino
- 60 classica
- 62 taormina
- 64 sorrento
- 68 sorrento corner
- 70 square
- 72 capri

74 lavabi / washbasins

- 76 appoggio-incasso
countertop-recessed
- 78 minima 2.0
- 80 minima appoggio
- 82 minima incasso
- 84 wave appoggio
- 85 six appoggio
- 86 skin appoggio
- 88 skin incasso
- 90 cosmos appoggio
- 92 five appoggio
- 94 portofino appoggio
- 95 star appoggio
- 96 star incasso
- 98 lavabi a muro
wall-mounted basins
- 100 shark
- 102 belmonte
- 106 lydia
- 108 five
- 110 lavabi con vasca integrata
basins with integrated bowl
- 112 max
- 114 basin
- 116 linea
- 118 plano
- 124 zen
- 126 link

- 128 lavabi a misura
bespoke basins
- 130 lavabi disponibili / bowl types
- 132 top a misura / bespoke basins
- 134 top scatolati a misura
/ boxed bespoke basins
- 138 freestanding
- 140 circle
- 142 kubic
- 144 five
- 146 royale
- 148 lisbona
- 148 boston
- 150 tribeca
- 152 minima column
- 154 five wall
- 154 minima wall
- 156 lavamani
handrinse
- 158 blade

160 piatti doccia / shower trays

- 162 cemento / concrete
- 164 edge
- 166 ardesia / slate
- 168 pietra / stone
- 171 liscio / smooth
- a misura / bespoke
- 172 liscio / smooth
- 174 pietra / stone

176 materiali / materials

- 178 materiali / materials
- 180 solid surface
- 181 cast marble
- 182 solid®
- 184 mineralsolid®
- 184 mineralmarmo®
- 186 certificazioni / certifications

vasche. bathtubs.

Il bagno come luogo dove vivere il Benessere assoluto, in un rituale sospeso nel tempo e nello spazio. Questa collezione di vasche freestanding e a misura, è nata per regalare atmosfere suggestive, dove relax e intimità si accompagnano alle parole bellezza e design. Le vasche progettate da Nicos International sono realizzate in Solid Surface e Mineralmarmo, tutte esprimono grande qualità produttiva e design esclusivo, con un attento studio del colore e con finiture superficiali che ricordano al tatto la pietra naturale levigata.

The bathroom is a place where we can experience total wellbeing and create rituals suspended in time and space. This collection of freestanding and made-to-measure bathtubs was developed to create evocative atmospheres, where relaxation and intimacy go hand in hand with beauty and design. Nicos International's bathtubs are made of Solid Surface and Mineralmarmo, and all feature high quality manufacturing and exclusive design, along with carefully selected colours and surface finishes reminiscent of the touch of natural polished stone.



siracusa

SOLID® (bianco opaco | white matt) + Bicolor ① + Deepcolor ②



codice code	dimensioni dimensions			capacità capacity
	L L	P D	H H	Lt Lt
C01416	150	82	55	280

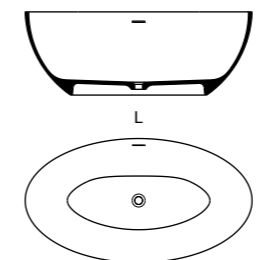

colori standard
standard colours



bianco
white tortora
tortora grigio
grey cenere
ash cappuccino
cappuccino nero
black

a richiesta
custom



ral/ncs

installazione
installation

centro stanza
freestanding

miscelatori
taps

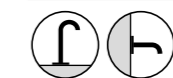

certificazioni
certifications



loop

SOLID® (bianco opaco | white matt) + Bicolor ① + Deepcolor ②



codice code	dimensioni dimensions			capacità capacity
	L L	P D	H H	Lt Lt
C01081	150	65	55	250

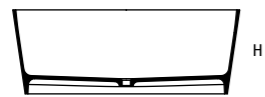

L

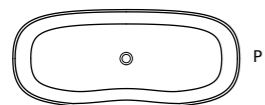

P

colori standard
standard colours



bianco
white

tortora
tortora

grigio
grey

cenere
ash

cappuccino
cappuccino

nero
black

a richiesta
custom



ral/ncs

installazione
installation

centro stanza
freestanding

miscelatori
taps

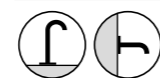

certificazioni
certifications



soft

SOLID® (bianco opaco | white matt) + Bicolor ① + Deepcolor ②



codice code	dimensioni dimensions	dimensioni dimensions			capacità capacity
		L L	P D	H H	
C01316	SMALL	150	76	60	258
C01054	MID	165	78	61	310
C01516	LARGE	180	80	61	352

colori standard
standard colours



bianco
white

tortora
tortora

grigio
grey

cenere
ash

cappuccino
cappuccino

nero
black

a richiesta
custom



ral/ncs

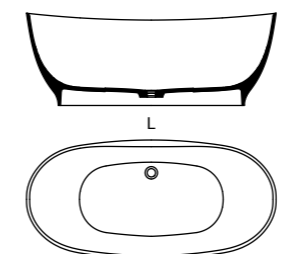

installazione
installation

centro stanza
freestanding

miscelatori
taps



certificazioni
certifications





bridge

SOLID® (bianco opaco | white matt) + Bicolor ① + Deepcolor ②



codice code	dimensioni dimensions	capacità capacity		
		L L	P D	H H
C01396 SMALL	150	74	56	260
C01103 MID	177	80	56	318

colori standard
standard colours



a richiesta
custom



ral/ncs

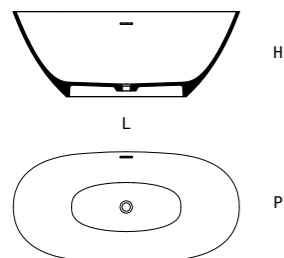

installazione
installation

centro stanza
freestanding

miscelatori
taps



certificazioni
certifications



■
Bicolor
RAL 8025



round

SOLID® (bianco opaco | white matt) + Bicolor ① + Deepcolor ②



codice code	dimensioni dimensions			capacità capacity
	L L	P D	H H	Lt Lt
C00982	150	70	50	247
C00763	169	80	50	313

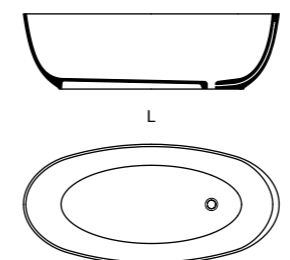

colori standard
standard colours



bianco
white

tortora
tortora

grigio
grey

cenere
ash

cappuccino
cappuccino

nero
black

a richiesta
custom



ral/ncs

installazione
installation

centro stanza
freestanding

miscelatori
taps



certificazioni
certifications



penny

SOLID® (bianco opaco | white matt) + Bicolor ● + Deepcolor ●



codice code	dimensioni dimensions	capacità capacity		
		L L	P D	H H
C01453 SMALL	160	70	52	268
C01228B MID	170	76	52	320
C01455 LARGE	180	80	52	370

colori standard
standard colours



bianco white
tortora tortora
grigio grey
cenere ash
cappuccino cappuccino
nero black

a richiesta
custom



ral/ncs

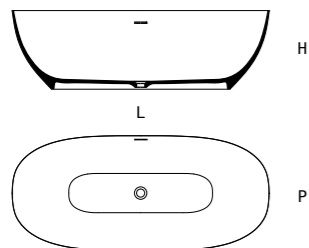

installazione
installation

centro stanza
freestanding

miscelatori
taps

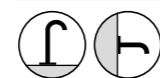

certificazioni
certifications



■
Bicolor
NCS S 4020-G10Y



■
Bicolor
NCS S 3050-Y70R

grace & solar

SOLID® (bianco opaco | white matt) + Bicolor ● + Deepcolor ●



codice code		dimensioni dimensions			capacità capacity
		L L	P D	H H	Lt Lt
C01517	MICRO	150	70	58	224
C01296	SMALL	160	70	58	238
C01343	MID	170	75	58	271
C01344	LARGE	180	80	58	316

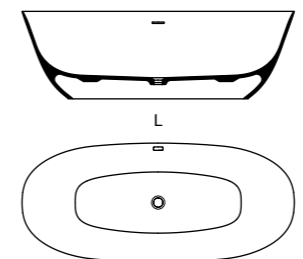

codice code		dimensioni dimensions			capacità capacity
		L L	P D	H H	Lt Lt
C01284		160	70	58	*

* senza troppo pieno
without over flow

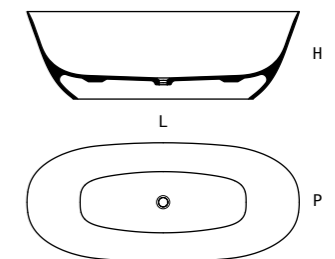

colori standard
standard colours



a richiesta
custom

installazione
installation

centro stanza
freestanding

miscelatori
taps



certificazioni
certifications





mood

SOLID® (bianco opaco | white matt) + Bicolor ① + Deepcolor ②



codice code	dimensioni dimensions			capacità capacity
	L L	P D	H H	Lt Lt
C01083	165	65	50	240

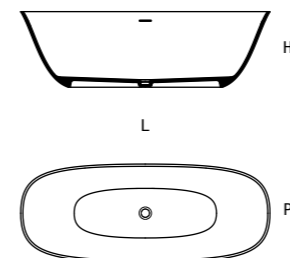

colori standard
standard colours



**a richiesta
custom**



ral/ncs

installazione
installation

centro stanza
freestanding

miscelatori
taps



certificazioni
certifications



evolution

SOLID® (bianco opaco | white matt) + Bicolor ● + Deepcolor ●



codice code	dimensioni dimensions			capacità capacity
	L L	P D	H H	
C01053	170	76	55	307

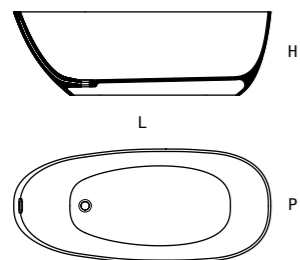

colori standard
standard colours



bianco white
tortora tortora
grigio grey
cenere ash
cappuccino cappuccino
nero black

a richiesta
custom



ral/ncs

installazione
installation

centro stanza
freestanding

miscelatori
taps

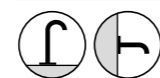

certificazioni
certifications



■
Bicolor
NCS S 3050-Y70R



krizia

SOLID® (bianco opaco | white matt) + Bicolor ① + Deepcolor ②

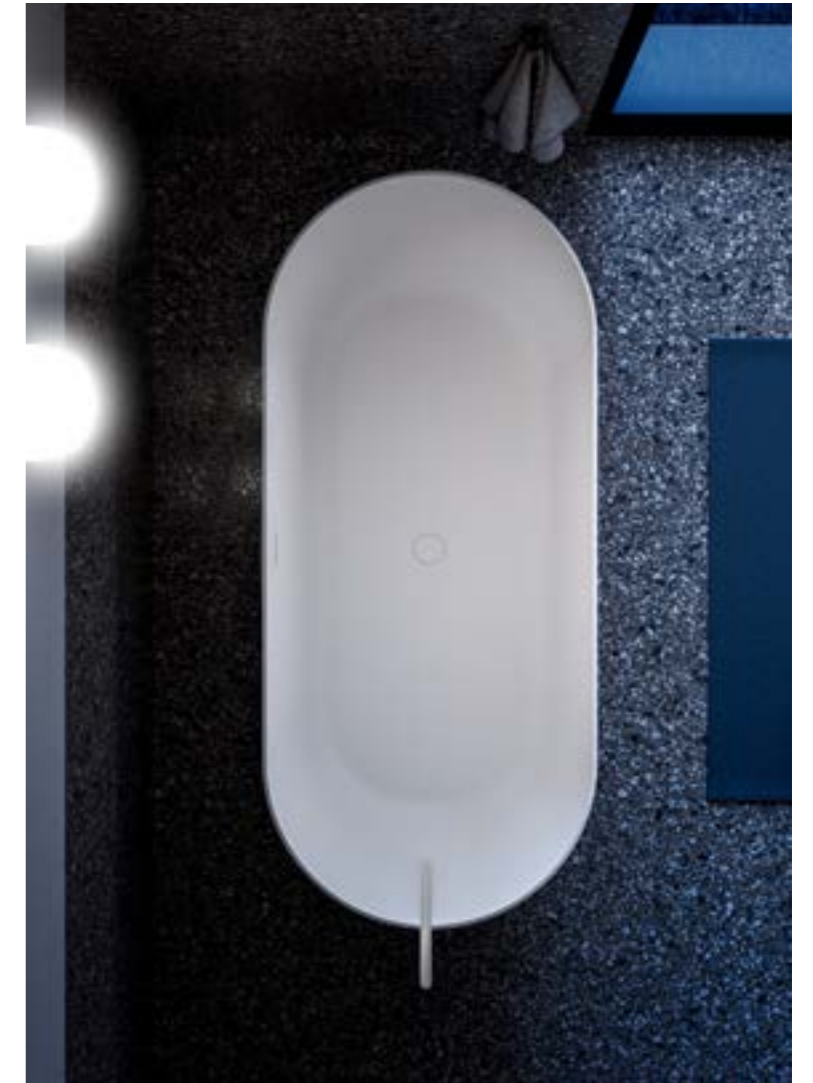

codice code	dimensioni dimensions			capacità capacity
	L L	P D	H H	Lt Lt
C01244	170	75	55	338

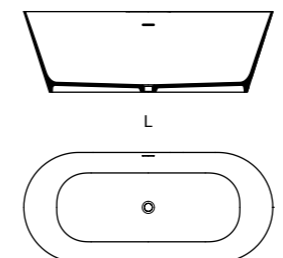

colori standard
standard colours



bianco
white

tortora
tortora

grigio
grey

cenere
ash

cappuccino
cappuccino

nero
black

a richiesta
custom



ral/ncs

installazione
installation

centro stanza
freestanding

miscelatori
taps



certificazioni
certifications



amalfi

SOLID® (bianco opaco | white matt) + Bicolor ● + Deepcolor ●



codice code	dimensioni dimensions			capacità capacity
	L L	P D	H H	
C01415	170	80	61	390

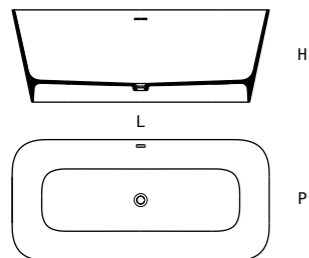

colori standard standard colours



installazione installation

centro stanza
freestanding

miscelatori taps

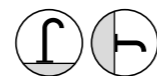

certificazioni certifications



a richiesta custom



ral/ncs



■
Deepcolor
cappuccino

wave

SOLID® (bianco opaco | white matt) + Bicolor ① + Deepcolor ②



codice code	dimensioni dimensions			capacità capacity
	L L	P D	H H	Lt Lt
C01082	170	75	55	290

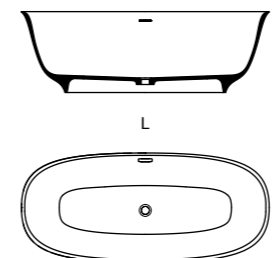

colori standard standard colours



a richiesta custom



ral/ncs

installazione installation

centro stanza
freestanding

miscelatori taps



certificazioni certifications





ibiza

SOLID® (bianco opaco | white matt) + Bicolor ① + Deepcolor ②



codice code	dimensioni dimensions			capacità capacity
	L L	P D	H H	
C01313	172	84	67	331

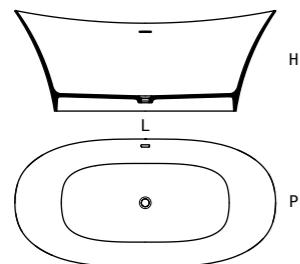

colori standard
standard colours



bianco
white

tortora
tortora

grigio
grey

cenere
ash

cappuccino
cappuccino

nero
black

a richiesta
custom



ral/ncs

installazione
installation

centro stanza
freestanding

miscelatori
taps

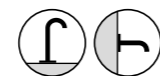

certificazioni
certifications



bold

SOLID® (bianco opaco | white matt) + Bicolor ① + Deepcolor ②

■ **Deepcolor**
NCS S 5030-Y70R



codice code	dimensioni dimensions			capacità capacity
	L L	P D	H H	Lt Lt
C01080	175	80	55	250

colori standard
standard colours



a richiesta
custom



ral/ncs

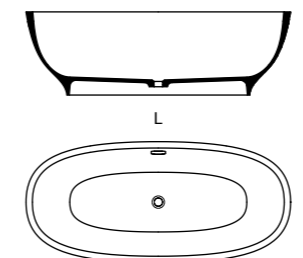

installazione
installation

centro stanza
freestanding

miscelatori
taps



certificazioni
certifications



portofino

SOLID® (bianco opaco | white matt) + Bicolor ● + Deepcolor ●



codice code	dimensioni dimensions			capacità capacity
	L L	P D	H H	Lt Lt
C01414	180	94	64	293

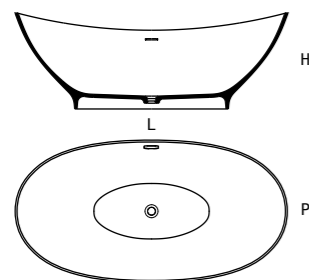

colori standard
standard colours



a richiesta
custom



ral/ncs

installazione
installation

centro stanza
freestanding

miscelatori
taps

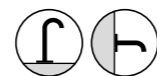



certificazioni
certifications





classica

SOLID® (bianco opaco | white matt) + Bicolor  + Deepcolor 

■
Bicolor
NCS S 5030-R90B



codice code	dimensioni dimensions			capacità capacity
	L L	P D	H H	Lt Lt
C01418	170	80	62	300

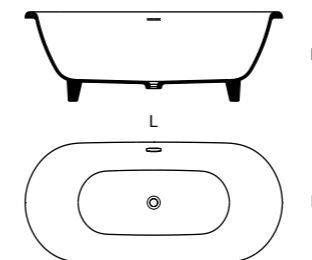

colori standard
standard colours



bianco
white

tortora
tortora

grigio
grey

cenere
ash

cappuccino
cappuccino

nero
black

a richiesta
custom



ral/ncs

installazione
installation

centro stanza
freestanding

miscelatori
taps

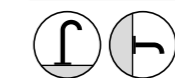

certificazioni
certifications



taormina

SOLID® (bianco opaco | white matt) + Bicolor ● + Deepcolor ●



codice code	dimensioni dimensions		H H	capacità capacity
	L L	P D		
C01417	120	120	55	330

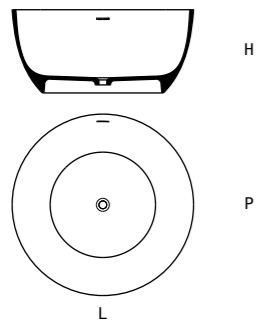

colori standard
standard colours



installazione
installation

centro stanza
freestanding

miscelatori
taps

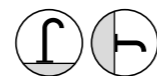

certificazioni
certifications



a richiesta
custom



ral/ncs



sorrento

SOLID® (bianco opaco | white matt) + Bicolor ① + Deepcolor ②



codice code	dimensioni dimensions			capacità capacity
	L L	P D	H H	Lt Lt
C01419	160	84	55	305

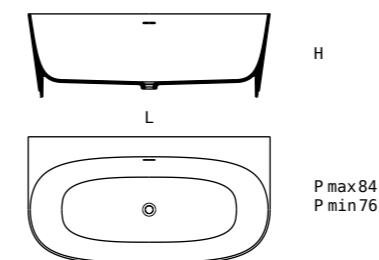

colori standard
standard colours



bianco
white

tortora
tortora

grigio
grey

cenere
ash

cappuccino
cappuccino

nero
black

**a richiesta
custom**



ral/ncs

installazione
installation

a parete
close to the wall

miscelatori
taps



certificazioni
certifications





■
Bicolor
NCS S 6020-Y40R

sorrento corner

SOLID® (bianco opaco | white matt) + Bicolor ① + Deepcolor ②



codice code	dimensioni dimensions	dimensioni dimensions		capacità capacity	
		L L	P D		H H
C01509 DX		170	70	55	280
C01510 SX		170	70	55	280

colori standard
standard colours



a richiesta
custom



destra
right

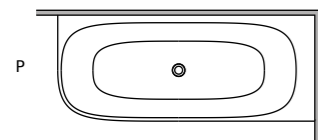
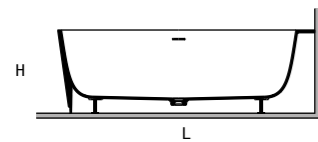

sinistra
left

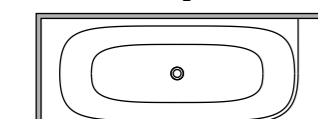
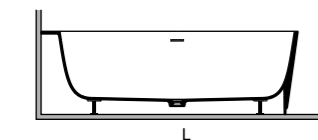

installazione
installation

angolo
close to the corner

miscelatori
taps

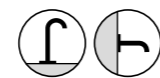

certificazioni
certifications



■ Bicolor
nero

square

SOLID® (bianco opaco | white matt) + Bicolor ① + Deepcolor ②



codice code	dimensioni dimensions			capacità capacity
	L L	P D	H H	Lt Lt
C00769	168	69	50	310

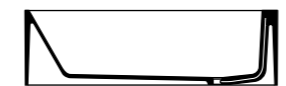

L

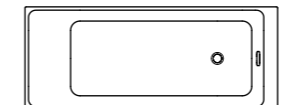

P

colori standard
standard colours



bianco
white tortora
tortora grigio
grey cenere
ash cappuccino
cappuccino nero
black

a richiesta
custom



ral/ncs

installazione
installation

centro stanza
freestanding

miscelatori
taps



certificazioni
certifications



capri

MINERALMARMO® (bianco lucido | white glossy)



codice code	dimensioni dimensions			capacità capacity
	L L	P D	H H	
V01502	150	80	55	256
V01464	180	80	55	294

colori standard
standard colours



bianco
white

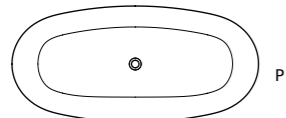

installazione
installation

centro stanza
freestanding

miscelatori
taps

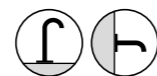

certificazioni
certifications



lavabi. washbasins.

Linee essenziali e un ricercato studio della forma che incontra la luce per dar vita ad elementi d'arredo esclusivi. I lavabi sviluppati da Nicos International trovano origine nel vero design, dove l'estetica abbraccia sempre la funzionalità. Qui la materia resta protagonista, priva di ogni futile accessorio, ed è all'origine della forma stessa. Le qualità del Solid Surface permettono di dar vita a forme inedite, colori pieni, grande flessibilità progettuale, il tutto racchiuso nella grande solidità strutturale, anche negli spessori più ridotti.

Minimalist lines and an in-depth study of how shape interacts with light as a means of creating exclusive furnishing elements. Nicos International's washbasins are rooted in true design, in which aesthetics always embraces functionality. The material reigns supreme, devoid of all trivial accessories, and plays a key role in the actual design. The qualities of Solid Surface enable highly unusual shapes and vibrant colours to be produced offering great flexibility in terms of design, all embodied within great structural solidity, even where thicknesses are reduced.

appoggio-incasso.
countertop-recessed.





■
Deepcolor
cenere

minima 2.0

appoggio
countertop

SOLID® (bianco opaco | white matt) + Bicolor ● + Deepcolor ●

codice | code dimensioni | dimensions
L|L P|D H|H

rettangolare | rectangular

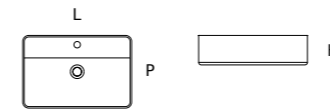

M08331 48 37 13
M08332 58 37 13

ovale | oval

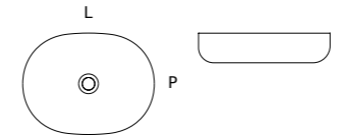

M08329 48 37 12
M08330 58 37 12

rotondo | round

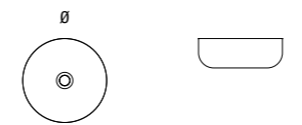

M08328 Ø37 12



colori standard
standard colours



a richiesta
custom



ral/ncs

miscelatori | taps



certificazioni | certifications



minima

appoggio
countertop

MINERALMARMO® (bianco lucido | white glossy)

SOLID® (bianco opaco | white matt) + Bicolor ● + Deepcolor ●

codice | code dimensioni | dimensions
L|L P|D H|H

rettangolare | rectangular

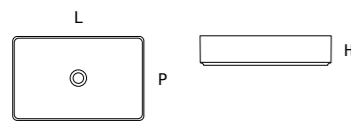

M08186 48 32 13
M07347 58 37 13

ovale | oval

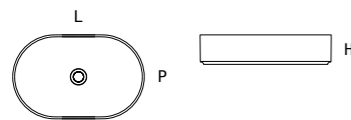

M08323 58 37 13

rotondo | round

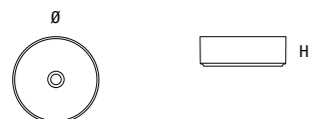

M07349 Ø37 13

quadrato | square

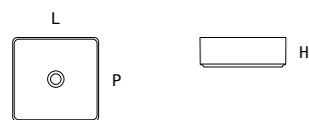

M07348 37 37 13



colori standard
standard colours



a richiesta
custom



ral/ncs

miscelatori | taps



certificazioni | certifications



■
Deepcolor
NCS S 4020-G10Y



minima

incasso
recessed

MINERALSOLID® (bianco opaco | white matt)
MINERALMARMO® (bianco lucido | white glossy)

codice | code dimensioni | dimensions
L|L P|D H|H S|T

rettangolare | rectangular

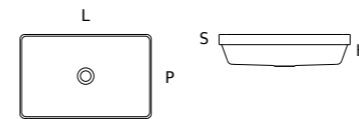

M07401 58 37 14 4.5

quadrato | square

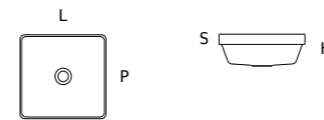

M07402 37 37 14 4.5

rotondo | round



M07403 Ø37 14 4.5



colori standard
standard colours



bianco
white

miscelatori | taps



certificazioni | certifications



wave

appoggio
countertop

SOLID® (bianco opaco | white matt) + Bicolor ● + Deepcolor ●



codice | code dimensioni | dimensions
L|L P|D H|H

ovale | oval

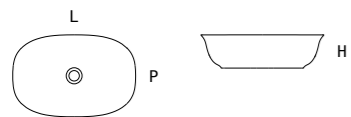

C01294	48	32	13
C01295	58	38	13

colori standard
standard colours



miscelatori | taps

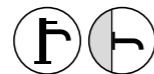

certificazioni | certifications



a richiesta
custom



ral/ncs

six

appoggio
countertop

SOLID® (bianco opaco | white matt) + Bicolor ● + Deepcolor ●



■
Bicolor
NCS S 3050-Y70R

codice | code dimensioni | dimensions
L|L P|D H|H

rettangolare | rectangular

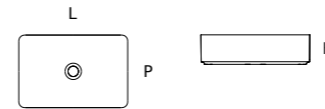

C01324	48	32	12.5
C01328	58	38	12.5

colori standard
standard colours



miscelatori | taps

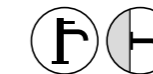

certificazioni | certifications



a richiesta
custom



ral/ncs



skin

appoggio
countertop

MINERALMARMO® (bianco lucido | white glossy)

SOLID® (bianco opaco | white matt) + Bicolor ● + Deepcolor ●

codice | code dimensioni | dimensions
L|L P|D H|H

rettangolare | rectangular

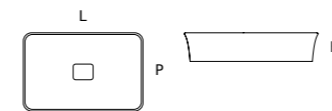

M07339 58 38 14

quadrato | square

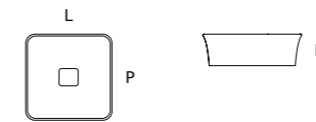

M07340 38 38 14

rotondo | round

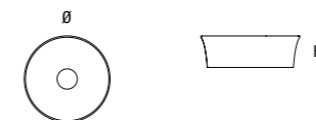

M07341 Ø38 14

ovale | oval

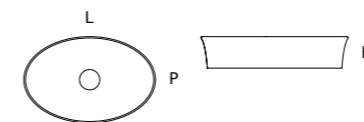

M07342 58 38 14



colori standard
standard colours



a richiesta
custom



ral/ncs

miscelatori | taps

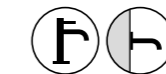

certificazioni | certifications



skin

incasso
recessed

MINERALMARMO® (bianco lucido | white glossy)

SOLID® (bianco opaco | white matt) + Bicolor ● + Deepcolor ●

codice | code dimensioni | dimensions
L|L P|D H|H S|T

rettangolare | rectangular

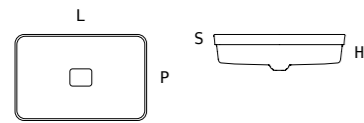

M07343 58 38 16 4.5

quadrato | square

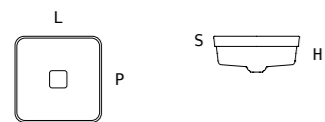

M07344 38 38 16 4.5

rotondo | round

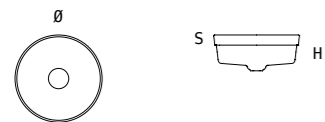

M07345 Ø38 16 4.5

ovale | oval

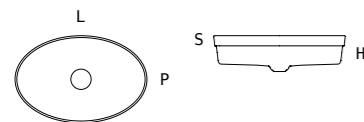

M07346 58 38 16 4.5



colori standard
standard colours



a richiesta
custom



ral/ncs

miscelatori | taps

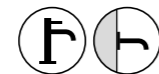

certificazioni | certifications



cosmos

appoggio
countertop

MINERALSolid® (bianco opaco | white matt)

MINERALMarmo® (bianco lucido | white glossy)

SOLID® (bianco opaco | white matt) + Bicolor ● + Deepcolor ●

codice | code dimensioni | dimensions
L|L P|D H|H

rettangolare | rectangular

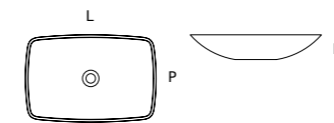

M06972 63 42 12

ovale | oval

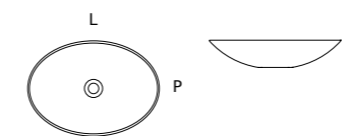

M06702 58 42 12
C00287 58 42 12

rotondo | round

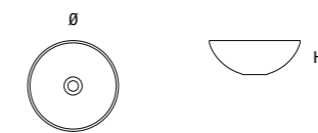

M06951 Ø40 15

ovale | oval

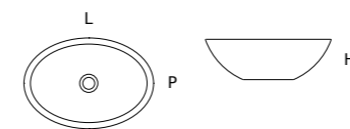

M06622 50 35 16

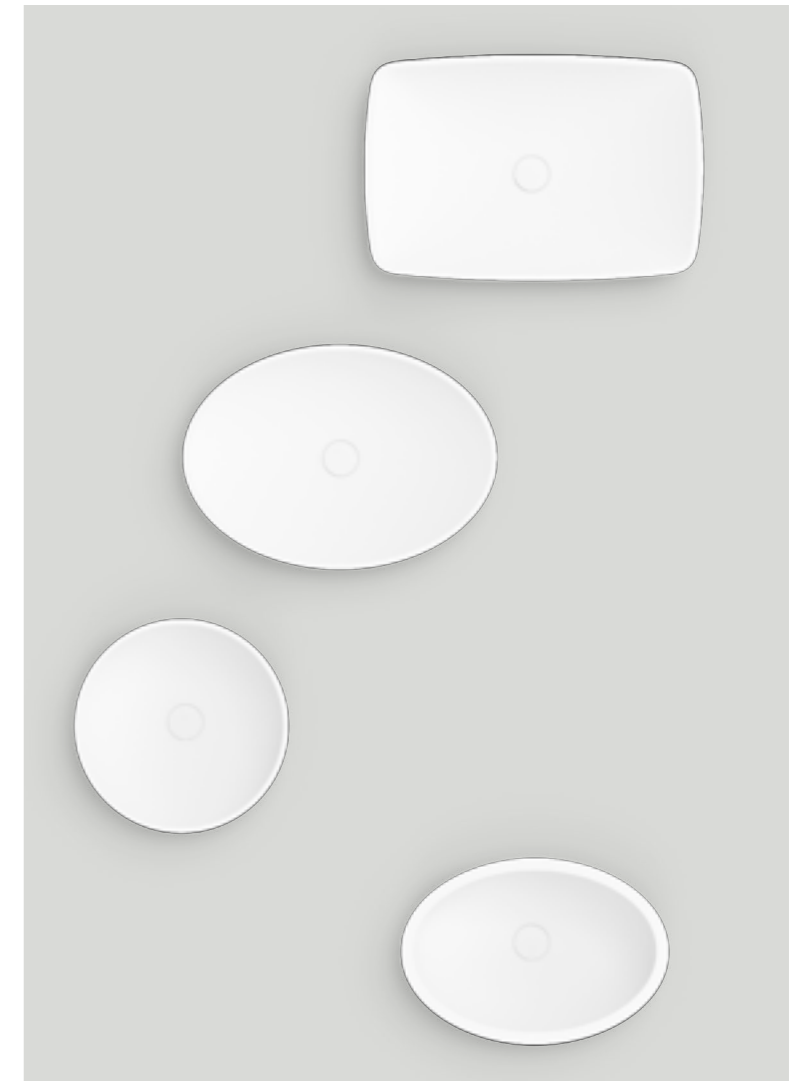

colori standard
standard colours



a richiesta
custom



ral/ncs

miscelatori | taps



certificazioni | certifications



five

appoggio
countertop

SOLID® (bianco opaco | white matt) + Bicolor ● + Deepcolor ●

codice | code dimensioni | dimensions
L|L P|D H|H

ovale | oval

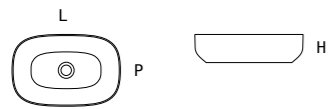

M08258	42	30	12.5
M08011	48	32	12.5
M08010	48	38	12.5
M08009	58	38	12.5

rotondo | round

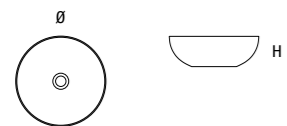

M08012	Ø40	12
--------	-----	----

rotondo | round

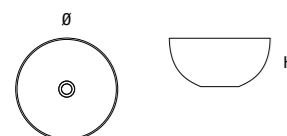

M08008	Ø45	22
--------	-----	----



colori standard
standard colours



a richiesta
custom



ral/ncs

miscelatori | taps

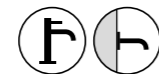

certificazioni | certifications



portofino

appoggio
countertop

SOLID® (bianco opaco | white matt) + Bicolor ● + Deepcolor ●



codice | code dimensioni | dimensions
L|L P|D H|H

ovale | oval

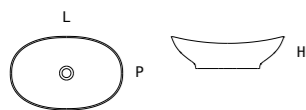

C01421 58 38 16.5

colori standard
standard colours



miscelatori | taps

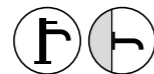

certificazioni | certifications



a richiesta
custom



ral/ncs

star

appoggio
countertop

SOLID® (bianco opaco | white matt) + Bicolor ● + Deepcolor ●



codice | code dimensioni | dimensions
L|L P|D H|H

rettangolare | rectangular

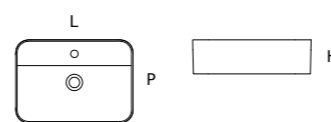

M08241 55 39 15

colori standard
standard colours



miscelatori | taps

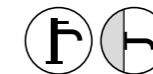

certificazioni | certifications



a richiesta
custom



ral/ncs

star

incasso
recessed
semi-incasso
semi-recessed

MINERALMARMO® (bianco lucido | white glossy)

SOLID® (bianco opaco | white matt) + Bicolor ● + Deepcolor ●

codice | code dimensioni | dimensions
L|L P|D H|H S|T

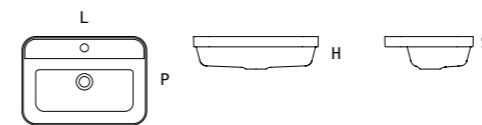

M07795 55 39 14.3 4.5
M07797 75 39 14.3 4.5

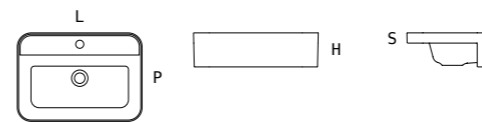

M07796 55 39 15 4.5
M07798 75 39 15 4.5



colori standard
standard colours



bianco
white tortora
tortora grigio
grey cenere
ash cappuccino
cappuccino nero
black

a richiesta
custom



ral/ncs

miscelatori | taps



certificazioni | certifications



lavabi a muro.
wall-mounted basins.



shark

MINERALSOLID® (bianco opaco | white matt)

MINERALMARMO® (bianco lucido | white glossy)

codice | code lunghezza | length

1 vasca | single bowl

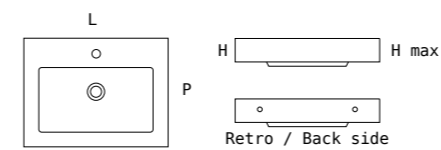

P D 46	M08134	L L	60.5
H H 10	M08337		70.5
H MAX 12	M08135		80.5
	M08136		90.5
	M08137		100.5
	M08138		120.5

2 vasche | double bowl

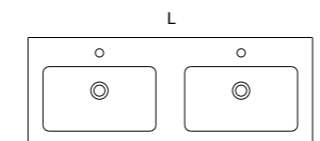

P D 46	M08139	L L	120.5
H H 10	M08140		140.5
H MAX 12			



colori standard
standard colours



bianco
white

miscelatori | taps



certificazioni | certifications



belmonte

MINERALSOLID® (bianco opaco | white matt)

MINERALSARMO® (bianco lucido | white glossy)

codice | code lunghezza | length

1 vasca | single bowl

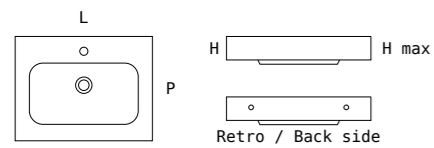

P D 46	M07673	L L	60.5
H H 12	M07674		70.5
H MAX 14	M07675		80.5
	M07676		90.5
	M07677		100.5
	M07678		120.5
	M08072		140.5

2 vasche | double bowl

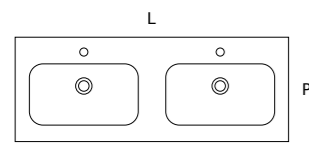

P D 46	M07681	L L	120.5
H H 12	M07682		140.5
H MAX 14			

1 vasca destra | single bowl - right

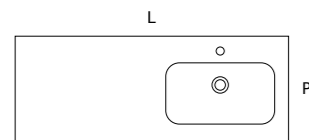

P D 46	M07679	L L	120.5
H H 12	M07894		120.5
H MAX 14			

1 vasca sinistra | single bowl - left

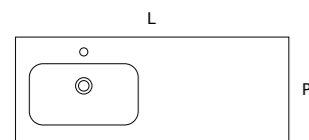

P D 46	M07680	L L	120.5
H H 12	M07895		120.5
H MAX 14			



colori standard
standard colours



bianco
white

miscelatori | taps

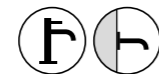

certificazioni | certifications







lydia

MINERALSOLID® (bianco opaco | white matt)

MINERALMARMO® (bianco lucido | white glossy)

codice | code lunghezza | length

1 vasca | single bowl

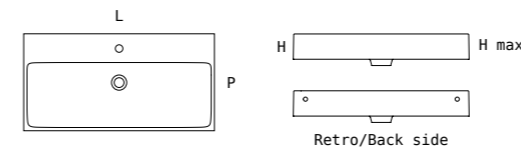

P D 46	M07739	L L	60.5
H H 12	M07740		70.5
H MAX 15	M07741		80.5
	M07658		90.5
	M07742		100.5
	M07743		110.5

2 vasche | double bowl

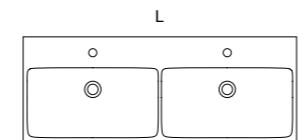

P D 46	M07744	L L	120.5
H H 12			
H MAX 15			



colori standard
standard colours



bianco
white

miscelatori | taps



certificazioni | certifications



five

SOLID® (bianco opaco | white matt) + Bicolor ● + Deepcolor ●

codice | code lunghezza | length

1 vasca | single bowl

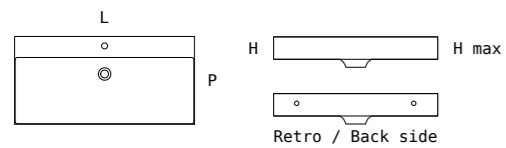

P D 46	M08037	L L	60.5
H H 10	M08038		70.5
H MAX 13.5	M08039		80.5
	M08040		90.5
	M07991		100.5
	M08041		120.5

1 vasca | single bowl

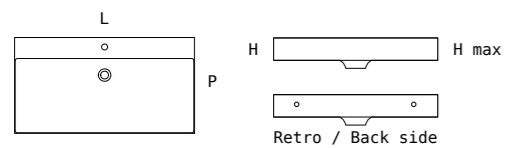

P D 51.5	M08358	L L	60.5
H H 10	M08398		70.5
H MAX 13.5	M08359		80.5
	M08399		90.5
	M08360		100.5
	M08361		120.5



colori standard
standard colours



a richiesta
custom



ral/ncs

miscelatori | taps

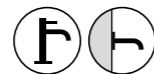

certificazioni | certifications



lavabi con vasca integrata.
basins with integrated bowl.



max

MINERALSOLID® (bianco opaco | white matt)

MINERALMARMO® (bianco lucido | white glossy)

codice | code lunghezza | length

codice | code lunghezza | length

P|D 46
H|H 11,5
S|T 1,5

1 vasca | single bowl

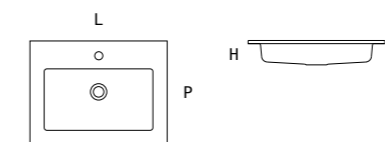

M08125	L L	60.5
M08189		70.5
M08126		80.5
M08127		90.5
M08128		100.5
M08129		120.5

2 vasche | double bowl

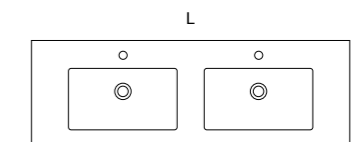

M08130	L L	120.5
M08131		140.5
M08387		160.5

1 vasca destra | single bowl R

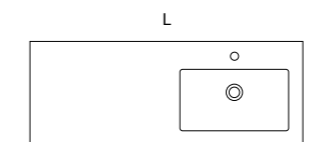

M08380	L L	90.5
M08383		120.5
M08209		120.5
M08132		120.5
M08335		140.5
M08385		160.5

1 vasca | sinistra single bowl L

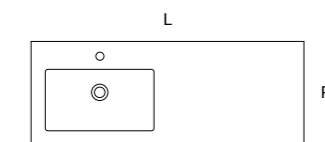

M08381	L L	90.5
M08384		120.5
M08210		120.5
M08133		120.5
M08336		140.5
M08386		160.5

P|D 51,5
H|H 11,5
S|T 1,5

1 vasca | single bowl

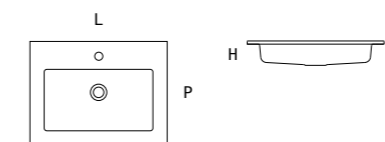

M08271	L L	60.5
M08272		70.5
M08273		80.5
M08274		90.5
M08275		100.5
M08276		120.5

2 vasche | double bowl

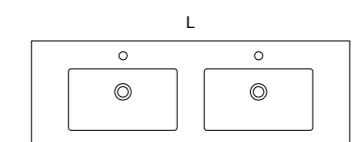

M08277	L L	120.5
M08278		140.5
M08279		160.5
M08280		180.5

colori standard | standard colours



bianco

miscelatori | taps



certificazioni | certifications



indice | index →

← indice | index

vegas

MINERALSOLID® (bianco opaco | white matt)

MINERALMARMO® (bianco lucido | white glossy)

codice | code lunghezza | length

P|D 46
H|H 14
S|T 1,5

1 vasca | single bowl

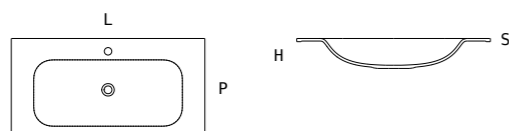

M08281	L L	60.5
M08282		70.5
M08283		80.5
M08284		90.5
M08302		100.5
M08292		120.5

1 vasca destra | single bowl R

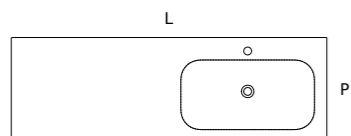

M08303	L L	120.5
M08299		140.5

codice | code lunghezza | length

2 vasche | double bowl

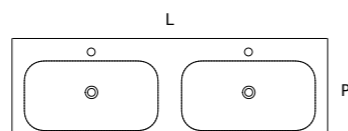

M08293	L L	120.5
M08298		140.5
M08315	L L	120.5
M07302		140.5

1 vasca | sinistra single bowl L

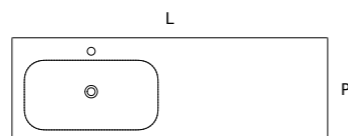

M08304	L L	120.5
M08300		140.5

P|D 50,6
H|H 14
S|T 1,5

1 vasca | single bowl

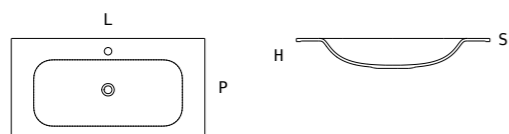

M08204	L L	60.5
M07303		70.5
M08205		80.5
M07314		90.5
M08320		100.5
M07956		120.5

1 vasca destra | single bowl R

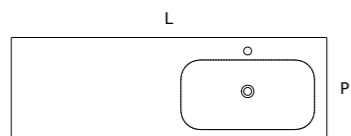

M08365	L L	120.5
--------	-----	-------

2 vasche | double bowl

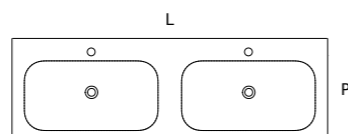

M08315	L L	120.5
M07302		140.5

1 vasca | sinistra single bowl L

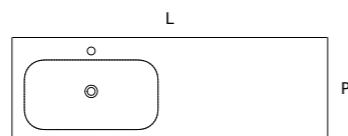

M08366	L L	120.5
--------	-----	-------

colori standard | standard colours



← indice | index

miscelatori | taps



certificazioni | certifications



indice | index →

linea

MINERALSOLID® (bianco opaco | white matt)

MINERALMARMO® (bianco lucido | white glossy)

P|D 46
H|H 16
S|T 1,5

codice | code lunghezza | length

1 vasca | single bowl

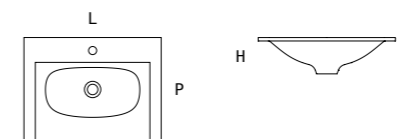

M07717	L L	60.5
M07718		70.5
M07719		80.5
M07663		90.5
M07720		100.5
M07721		105.5
M07722		110.5
M07723		120.5

1 vasca destra | single bowl R

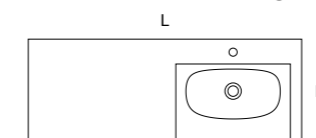

M07724	L L	120.5*
--------	-----	--------

codice | code lunghezza | length

2 vasche | double bowl

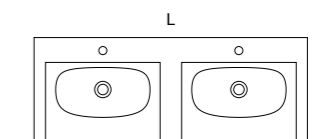

M07726	L L	120.5*
M07727		140.5**

1 vasca | sinistra single bowl L

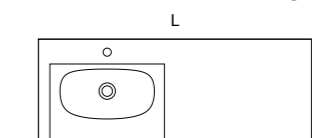

M07725	L L	120.5*
--------	-----	--------

P|D 51,5
H|H 16
S|T 1,5

1 vasca | single bowl

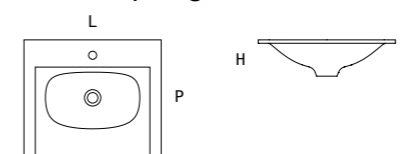

M07728	L L	60.5
M07729		70.5
M07730		80.5
M07938		85.5
M07662		90.5
M07937		95.5
M07731		100.5
M07732		105.5
M07733		110.5
M07734		120.5

1 vasca destra | single bowl R

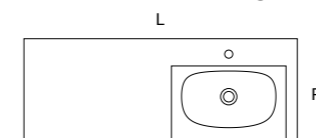

M07735	L L	120.5*
--------	-----	--------

2 vasche | double bowl

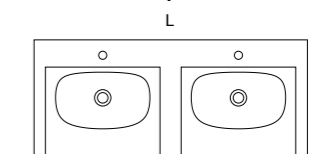

M07737	L L	120.5*
M07738		140.5**

1 vasca | sinistra single bowl L

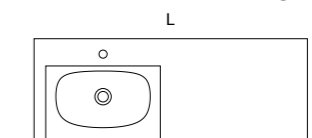

M07736	L L	120.5*
--------	-----	--------

*vasca per base da 60 cm | basin for 60 cm base unit **vasca per base da 70 cm | basin for 70 cm base unit

colori standard | standard colours



bianco

miscelatori | taps



certificazioni | certifications



indice | index →

← indice | index

plano

MINERALSOLID® (bianco opaco | white matt)

MINERALMARMO® (bianco lucido | white glossy)

codice | code

lunghezza | length

codice | code

lunghezza | length

P|D 35,5
H|H 14,3
S|T 1,5

1 vasca | single bowl

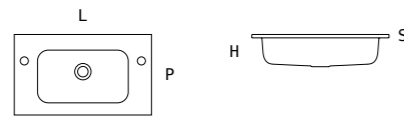

M06963	L L	60.5
M06895		70.5
M07333		80.5
M06964		90.5
M06894		95.5
M06890		105.5
M06879		120.5

P|D 40,5
H|H 14,3
S|T 1,5

1 vasca | single bowl

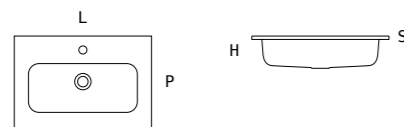

M06886	L L	60.5
M06837		70.5
M07286		80.5
M06836		90.5
M06970		95.5
M07421		100.5
M06971		105.5
M06885		120.5

2 vasche | double bowl

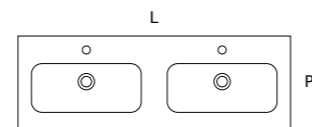

M07422	L L	120.5
--------	-----	-------

colori standard | standard colours



← indice | index

miscelatori | taps

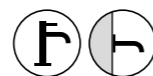

certificazioni | certifications



indice | index →

plano

MINERALSOLID® (bianco opaco | white matt)

MINERALMARMO® (bianco lucido | white glossy)

codice | code lunghezza | length

P|D 46
H|H 14,3
S|T 1,5

1 vasca | single bowl

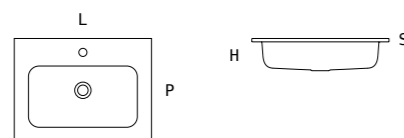

M06977	L L	60.5
M06978		70.5
M07245		80.5
M06979		90.5
M06980		95.5
M07246		100.5
M06981		105.5
M07332		110.5
M06982		120.5

2 vasche | double bowl

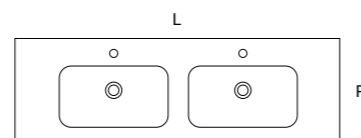

M06983	L L	120.5*
M07350		140.5**
M07518		160.5***
M07519		180.5****
M07496		200.5
M07458		200.5
M07497		220.5
M07459		240.5

1 vasca destra | single bowl R

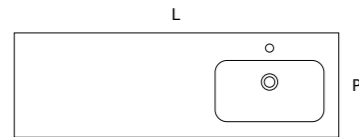

M07352	L L	80.5*
M07319		85.5*
M07666		90.5*
M07317		100.5*
M07330		105.5**
M07284		120.5*
M07328		120.5**
M07510		140.5*
M07514		140.5***
M07512		160.5**
M07516		160.5**

2 vasche sinistra | double bowl L

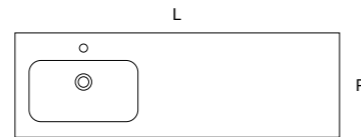

M07353	L L	80.5*
M07320		85.5*
M07667		90.5*
M07318		100.5*
M07331		105.5**
M07285		120.5*
M07329		120.5**
M07511		140.5*
M07515		140.5***
M07513		160.5**
M07517		160.5**

*vasca per base da 60 cm | basin for 60 cm base unit **vasca per base da 70 cm | basin for 70 cm base unit
vasca per base da 80 cm | basin for 80 cm base unit *vasca per base da 90 cm | basin for 90 cm base unit

colori standard | standard colours



← indice | index

miscelatori | taps



certificazioni | certifications



indice | index →

plano

MINERALSOLID® (bianco opaco | white matt)

MINERALMARMO® (bianco lucido | white glossy)

codice | code lunghezza | length

P|D 50,5
H|H 14,3
S|T 1,5

1 vasca | single bowl

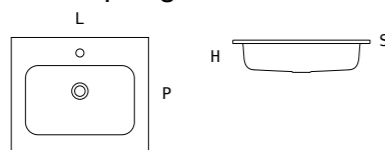

M06986	L L	60.5
M07500		70.5
M07071		75.5
M07418		80.5
M07570		85.5
M06988		90.5
M07571		95.5
M07419		100.5
M07501		105.5
M06987		120.5

1 vasca destra | single bowl R

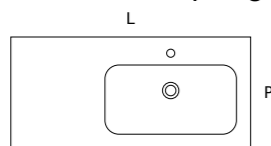

M07572	L L	105.5**
M07574		120.5**

codice | code lunghezza | length

2 vasche | double bowl

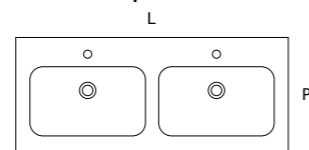

M07420	L L	120.5**
--------	-----	---------

2 vasche sinistra | double bowl L

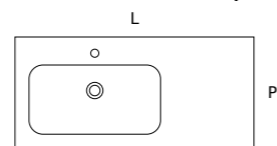

M07573	L L	105.5**
M07575		120.5**

P|D 51,5
H|H 14,3
S|T 1,5

1 vasca | single bowl

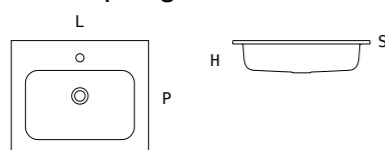

M06869	L L	60.5
M06816		70.5
M07364		80.5
M06925		85.5
M06814		90.5
M06877		95.5
M06878		105.5
M06809		110.5
M06858		120.5

1 vasca destra | single bowl R

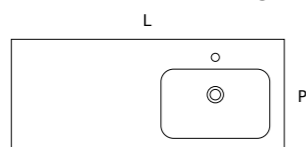

M07751	L L	105.5**
M07058		120.5*
M07444		120.5**

2 vasche | double bowl

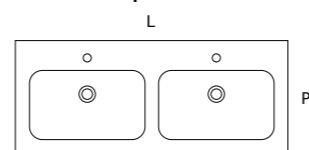

M06965	L L	120.5
M07446		140.5*
M07447		160.5**
M07448		180.5***
M07498		200.5
M07499		220.5

2 vasche sinistra | double bowl L

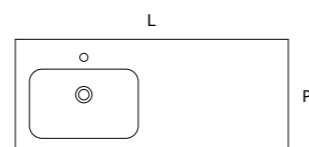

M07752	L L	105.5**
M07059		120.5*
M07445		120.5**

*vasca per base da 60 cm | basin for 60 cm base unit **vasca per base da 70 cm | basin for 70 cm base unit

vasca per base da 80 cm | basin for 80 cm base unit *vasca per base da 90 cm | basin for 90 cm base unit

colori standard | standard colours



← indice | index

miscelatori | taps



certificazioni | certifications



indice | index →



zen

MINERALSOLID® (bianco opaco | white matt)

MINERALMARMO® (bianco lucido | white glossy)

codice | code lunghezza | length

P|D 46
H|H 14
S|T 1,5

1 vasca | single bowl

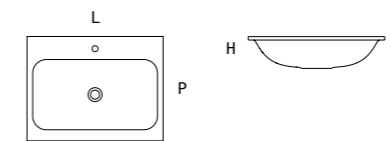

M07256	L L	60.5
M07257		70.5
M07258		80.5
M07259		90.5
M07260		100.5
M07261		120.5

1 vasca destra | single bowl R

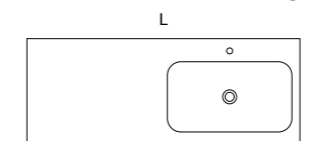

M07263	L L	120.5*
M07288		120.5**

codice | code lunghezza | length

2 vasche | double bowl

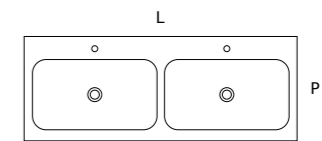

M07262	L L	120.5
--------	-----	-------

2 vasche sinistra | double bowl L

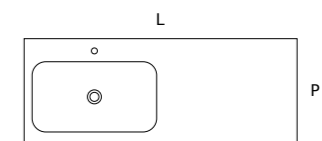

M07264	L L	120.5*
M07289		120.5**

P|D 51,5
H|H 14
S|T 1,5

1 vasca | single bowl

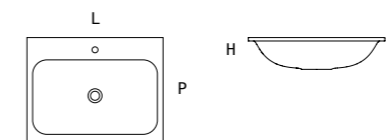

M07198	L L	60.5
M07199		70.5
M07200		80.5
M07201		90.5
M07202		100.5
M07439		100.5
M07220		100.5
M07203		120.5

1 vasca destra | single bowl R

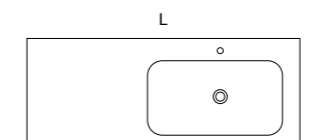

M07800	L L	100.5*
M07749		105.5*
M07204		120.5

2 vasche | double bowl

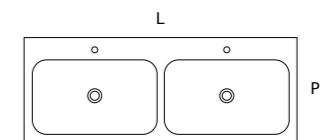

M07206	L L	120.5
M07207		140.5
M07754		180.5

2 vasche sinistra | double bowl L

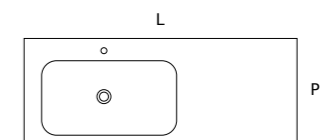

M07552	L L	100.5*
M07750		105.5*
M07205		120.5

*vasca per base da 60 cm | basin for 60 cm base unit **vasca per base da 70 cm | basin for 70 cm base unit

colori standard | standard colours



bianco

miscelatori | taps



certificazioni | certifications



link

MINERALSOLID® (bianco opaco | white matt)
MINERALMARMO® (bianco lucido | white glossy)

codice | code lunghezza | length

P/D 46
H/H 13,5
S/T 1,5

1 vasca | single bowl

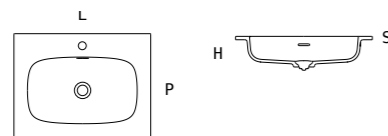

M08613	L L	60.5
M08614		70.5
M08615		80.5
M08616		90.5
M08617		100.5
M08618		120.5

codice | code lunghezza | length

2 vasche | double bowl

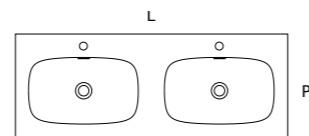

M08623	L L	120
M08624		140
M08625		160

1 vasca destra | single bowl R

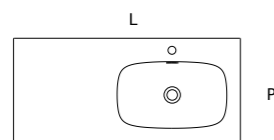

M08619	L L	100.5
M08621		120.5

2 vasche sinistra | double bowl L

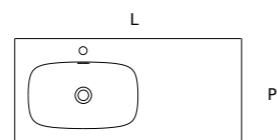

M08620	L L	100.5
M08622		120.5

colori standard | standard colours



← indice | index

miscelatori | taps

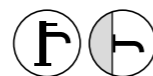

certificazioni | certifications



indice | index →

**lavabi a misura.
bespoke basins.**



LAVABI DISPONIBILI | BOWL AVAILABLE



1138 Lavabo dim. Ø 31,5 cm
Bowl Ø 31.5 cm



1142 Lavabo dim.58x27 cm
Bowl size 58x27 cm



1148 Lavabo dim.58x31,5 cm
Bowl size 58x31.5 cm



1310 Lavabo dim.60x31 cm
Bowl size 60x31 cm



826 Lavabo dim.54,2x31,1 cm
Bowl size 54.2x31.1 cm



1451 Lavabo dim.48x30,5 cm
Bowl size 48x30.5 cm



1143 Lavabo dim.58x27 cm
Bowl size 58x27 cm



1149 Lavabo dim.58x31,5 cm
Bowl size 58x31.5 cm



1325 Lavabo dim.50x27 cm
Bowl size 50x27 cm



1330 Lavabo dim.60x27 cm
Bowl size 60x27 cm



1144 Lavabo dim.58x27 cm
Bowl size 58x27 cm



1150 Lavabo dim.58x31,5 cm
Bowl size 58x31.5 cm



1329 Lavabo dim.50x31,5 cm
Bowl size 50x31.5 cm



1331 Lavabo dim.60x31,5 cm
Bowl size 60x31.5 cm



1139 Lavabo dim.48x27 cm
Bowl size 48x27 cm



1145 Lavabo dim.48x31,5 cm
Bowl size 48x31.5 cm



1337 Lavabo dim.58x31 cm
Bowl size 58x31 cm



1332 Lavabo dim.61,5x36,5 cm
Bowl size 61.5x36.5 cm



1397 Lavabo dim.62,9x33,1 cm
Bowl size 62.9x33.1 cm



1140 Lavabo dim.48x27 cm
Bowl size 48x27 cm



1146 Lavabo dim.48x31,5 cm
Bowl size 48x31.5 cm



1339 Lavabo dim.60x27,5 cm
Bowl size 60x27.5 cm



1435 Lavabo dim.80x31 cm
Bowl size 80x31 cm



1141 Lavabo dim.54,8x31 cm
Bowl size 54.8x31 cm



1147 Lavabo dim.48x31,5 cm
Bowl size 48x31.5 cm



1441 Lavabo dim.54,8x31 cm
Bowl size 54.8x31 cm



8185 Lavabo dim.68x29 cm
Bowl size 68x29 cm

top a misura | bespoke basins

SOLID® (bianco opaco | white matt) + Bicolor ① + Deepcolor ●



VASCA SINGOLA
SINGLE BOWL



VASCA DOPPIA
DOUBLE BOWL

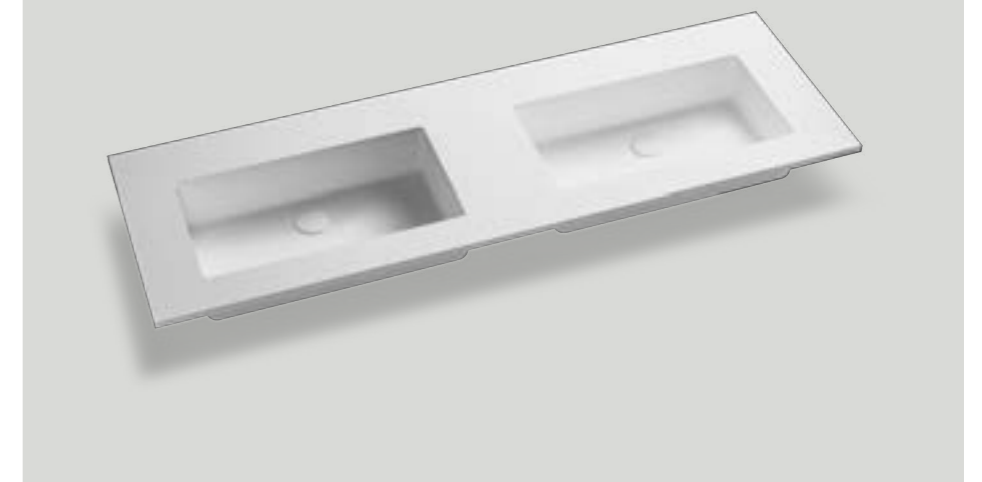

colori standard
standard colours



bianco **tortora** **grigio** **cenere** **cappuccino** **nero**
white tortora grey ash cappuccino black

a richiesta
custom



ral/ncs

miscelatori
taps

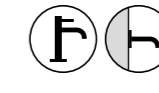

certificazioni
certifications



top scatolati a misura

bespoke basins with apron

SOLID® (bianco opaco | white matt) + Bicolor ● + Deepcolor ●

VASCA SINGOLA
SINGLE BOWL



VASCA DOPPIA
DOUBLE BOWL



colori standard
standard colours



bianco
white

tortora
tortora

grigio
grey

cenere
ash

cappuccino
cappuccino

nero
black

a richiesta
custom



ral/ncs

miscelatori
taps

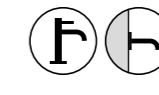

certificazioni
certifications



LA VASCA ABBINATA AL TOP | THE CORRECT BOWL FOR THE TOP

Profondità 46 cm - Vasca singola

Depth 46 cm - Single bowl

Lunghezza minima del top (cm) per vasca singola
Minimum top length (cm) for single bowl

codice code	50	60	70	80	90
1138					
1139					
1140					
1141					
1142					
1143					
1144					
1325					
1330					
1339					

Profondità 46 cm - Vasca doppia

Depth 46 cm - Double bowl

Lunghezza minima del top (cm) per vasca doppia
Minimum top length (cm) for double bowl

codice code	90	120	140	160	190
1138					
1139					
1140					
1141					
1142					
1143					
1144					
1325					
1330					
1339					

Profondità 51,5 cm - Vasca singola

Depth 51.5 cm - Single bowl

Lunghezza minima del top (cm) per vasca singola
Minimum top length (cm) for single bowl

codice code	50	60	70	80
826				
1138				
1145				
1146				
1147				
1148				
1149				
1150				
1310				
1329				
1331				
1332				
1337				
1397				
1435				
1441				
1451				
8185				

Profondità 51,5 cm - Vasca doppia

Depth 51.5 cm - Double bowl

Lunghezza minima del top (cm) per vasca doppia
Minimum top length (cm) for double bowl

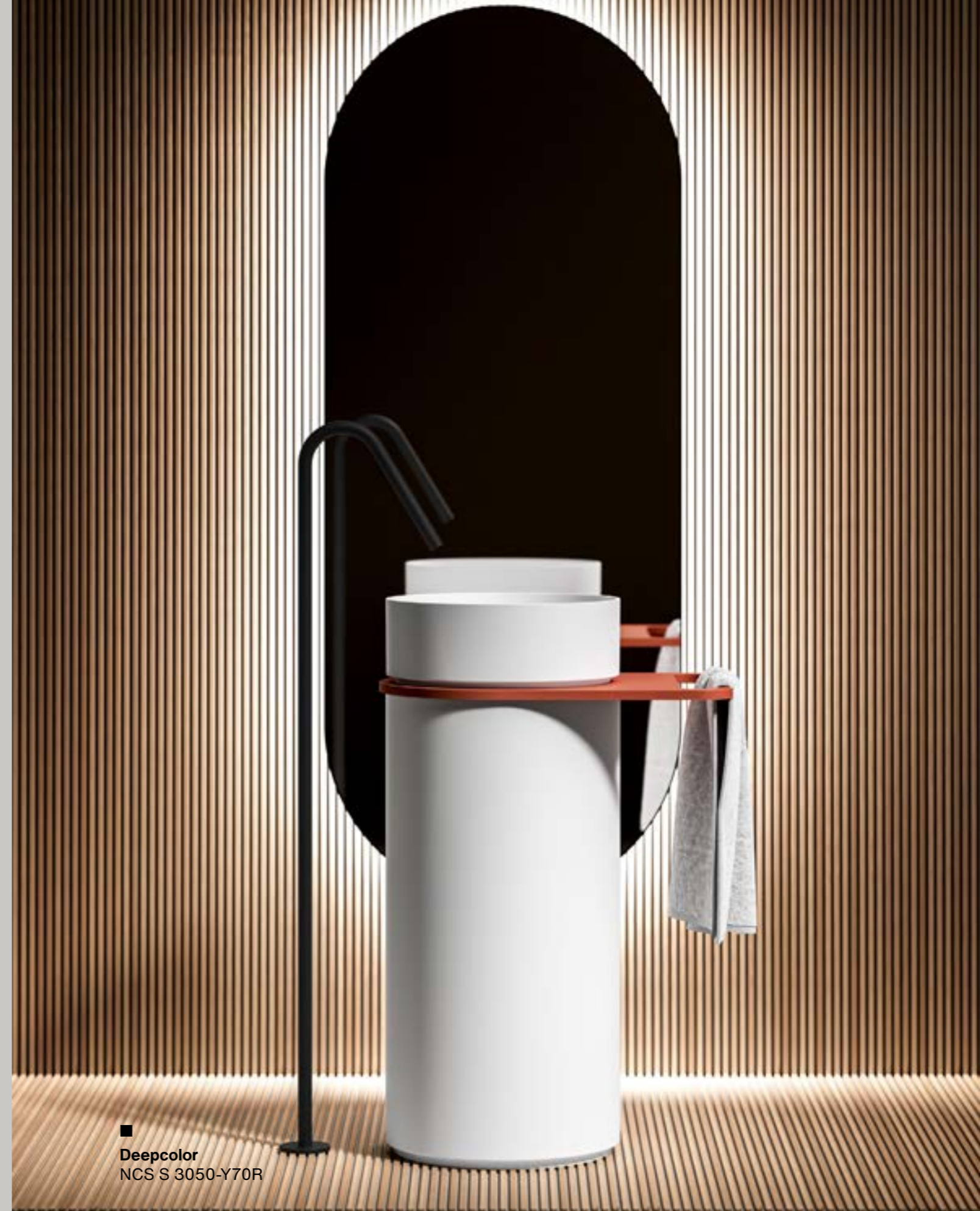

codice code	90	120	140	160	180
826					
1138					
1145					
1146					
1147					
1148					
1149					
1150					
1310					
1329					
1331					
1332					
1337					
1397					
1435					
1441					
1451					
8185					

freestanding.



■ **Deepcolor**
NCS S 3050-Y70R

circle

SOLID® (bianco opaco | white matt) + Bicolor  + Deepcolor 



codice code	dimensioni dimensions	
	H H	
C00917	Ø 44	87

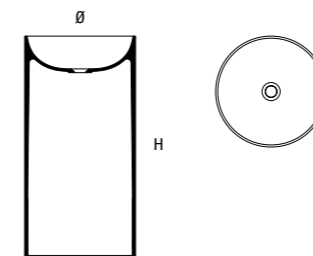

codice code	dimensioni dimensions	
	H H	
C01000	Ø 44	87

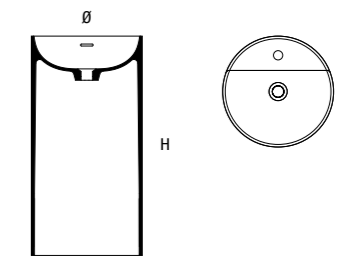

colori standard
standard colours



a richiesta
custom



installazione
installation

centro stanza
freestanding
a parete
near the wall

miscelatori
taps

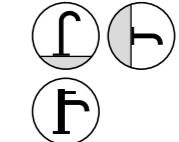

certificazioni
certifications



kubic

SOLID® (bianco opaco | white matt) + Bicolor ● + Deepcolor ●



codice | code dimensioni | dimensions

	L L	P D	H H
C01527	40	40	87

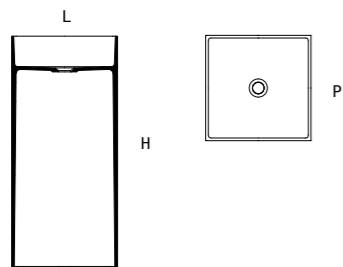

codice | code dimensioni | dimensions

	L L	P D	H H
C01157	44	44	87

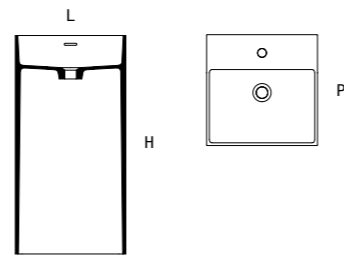

colori standard
standard colours



a richiesta
custom



installazione
installation

centro stanza
freestanding

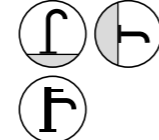

miscelatori
taps



certificazioni
certifications



five

SOLID® (bianco opaco | white matt) + Bicolor  + Deepcolor 



codice code	dimensioni dimensions		
	L L	P D	H H
C01360	48	38	87

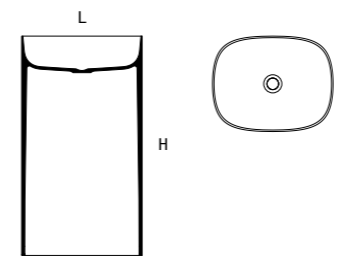

codice code	dimensioni dimensions		
	L L	P D	H H
C01367	48	44	87

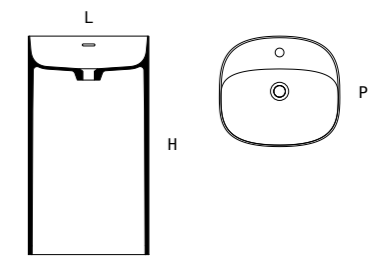

colori standard
standard colours



a richiesta
custom



installazione
installation

centro stanza
freestanding
a parete
near the wall

miscelatori
taps

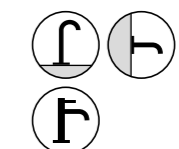

certificazioni
certifications



royale

SOLID® (bianco opaco | white matt) + Bicolor ● + Deepcolor ●



codice | code dimensioni | dimensions

	L L	P D	H H
C01468	58	48	87

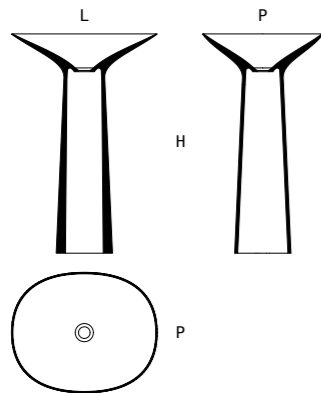

colori standard
standard colours



a richiesta
custom



installazione
installation

centro stanza
freestanding

a parete
near the wall

miscelatori
taps

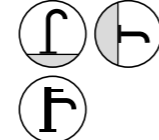

certificazioni
certifications



lisbona

boston

SOLID® (bianco opaco | white matt) + Bicolor ● + Deepcolor ●



codice | code dimensioni | dimensions

L|L P|D H|H

C01474 51 83/92

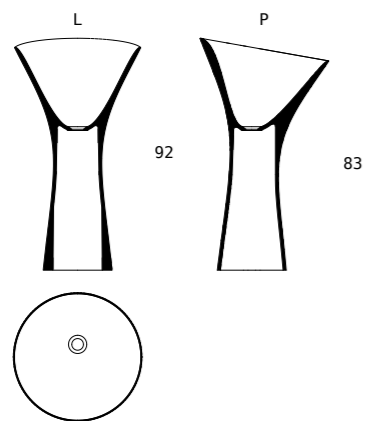

codice | code dimensioni | dimensions

L|L P|D H|H

C01475 51 47 83/92

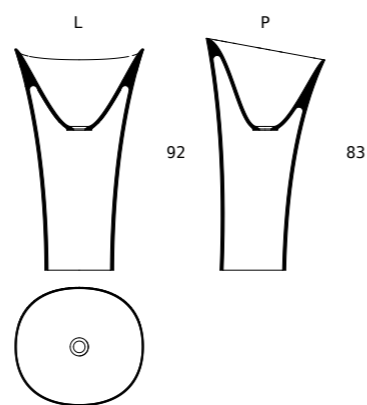

colori standard
standard colours



a richiesta
custom



installazione
installation

centro stanza
freestanding

a parete
near the wall

miscelatori
taps

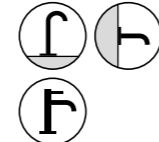

certificazioni
certifications



tribeca

SOLID® (bianco opaco | white matt) + Bicolor ① + Deepcolor ②



codice | code dimensioni | dimensions

H|H

C01480 Ø 58 87

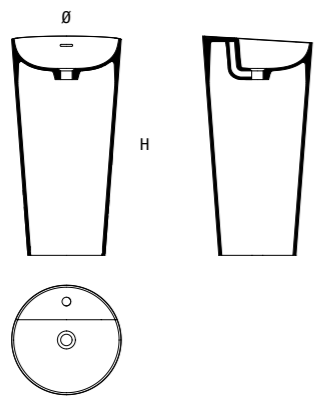

colori standard
standard colours



a richiesta
custom



installazione
installation

centro stanza
freestanding

miscelatori
taps

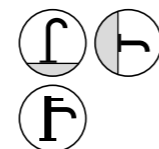

certificazioni
certifications



minima column

SOLID® (bianco opaco | white matt) + Bicolor ① + Deepcolor ●

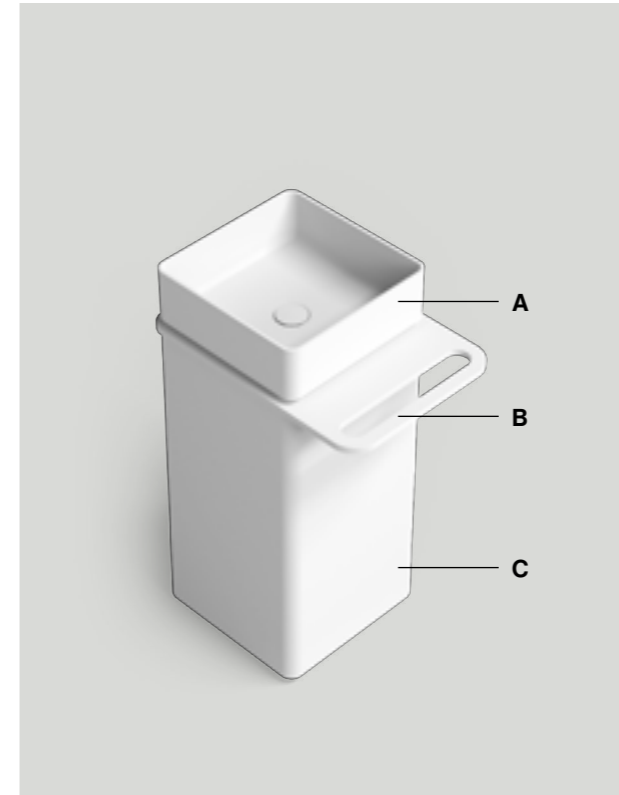

codice code	dimensioni dimensions		
	L L	P D	H H
A M07348	37	37	13
B X00401A	55	39	1.5
C C01526A	37	37	72.5

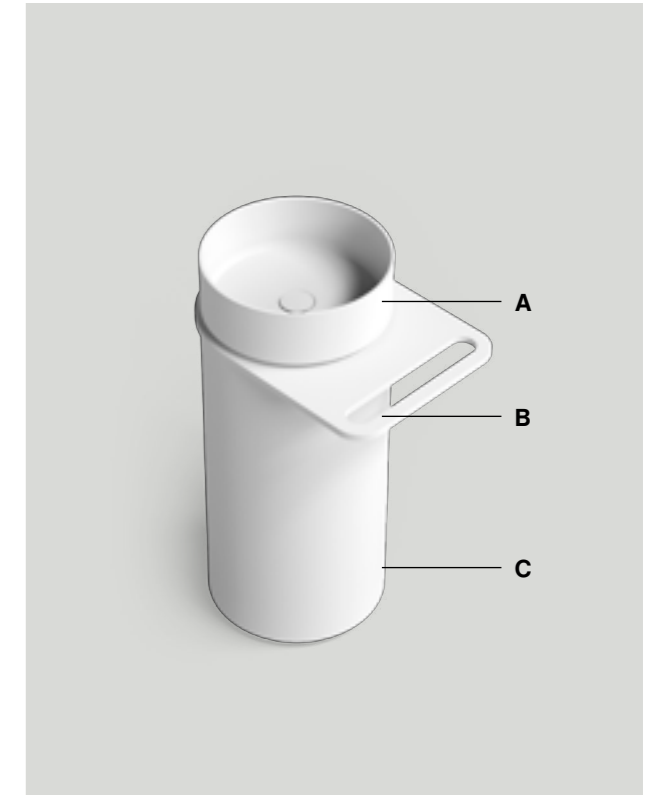

codice code	dimensioni dimensions		
	L L	P D	H H
A M07349	Ø 37		13
B X00400A	55	39	1.5
C C01525A	Ø 37		72.5

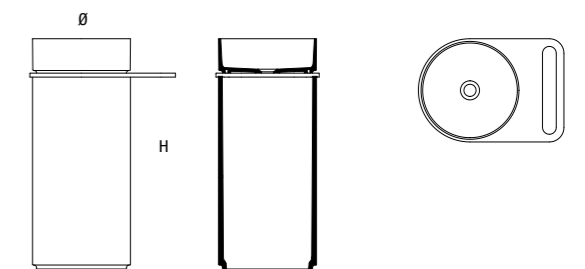
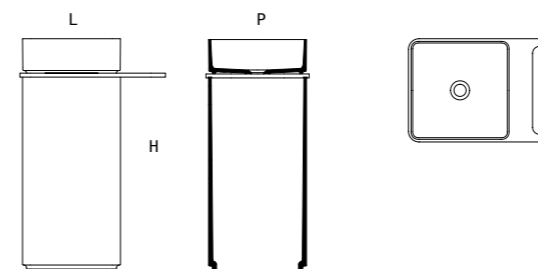

colori standard
standard colours



bianco white
tortora tortora
grigio grey
cenere ash
cappuccino cappuccino
nero black

a richiesta
custom



ral/ncs

installazione
installation

centro stanza
freestanding

miscelatori
taps



certificazioni
certifications



indice | index →

■ Deepcolor
NCS S 6020-Y40R

five wall

minima wall

SOLID® (bianco opaco | white matt) + Bicolor ● + Deepcolor ●



codice | code dimensioni | dimensions

	L L	P D	H H
C01523	60	38	30

destra
right



sinistra
left

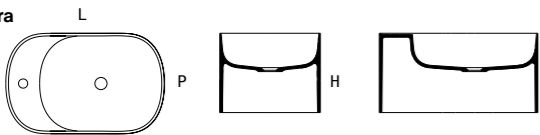

colori standard
standard colours



bianco white tortora tortora grigio grey cenere ash cappuccino cappuccino nero black

a richiesta
custom



ral/ncs

installazione
installation

centro stanza
freestanding

a parete
near the wall

miscelatori
taps

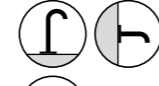

certificazioni
certifications



codice | code dimensioni | dimensions

	L L	P D	H H
C01524	58	38	30

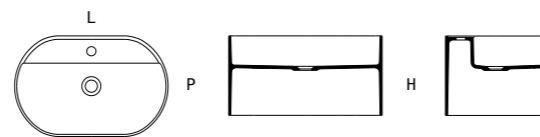

■
Deepcolor
NCS S 4020-G10Y

lavamani. handrinse.



blade

SOLID® (bianco opaco | white matt) + Bicolor ① + Deepcolor ②

codice | code dimensioni | dimensions
L|L P|D H|H

rettangolare | rectangular

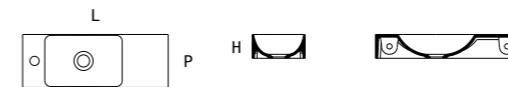

C01522	55	20	9
C01494	40	20	9

quadrato | square

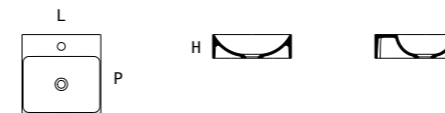

C01521	30	30	9
--------	----	----	---



colori standard
standard colours



bianco white	tortora tortora	grigio grey	cenere ash	cappuccino cappuccino	nero black
-----------------	--------------------	----------------	---------------	--------------------------	---------------

a richiesta
custom



ral/ncs

installazione
installation

centro stanza
freestanding

miscelatori
taps



certificazioni
certifications



piatti doccia. shower trays.

Le collezioni dei piatti doccia di Nicos International sono state sviluppate con lo scopo di esaltare i sensi. Ogni dettaglio è disegnato per regalare armonia e integrare questo elemento in modo totalizzante nel design progettuale. L'impiego sapiente del Mineralsolid permette di creare finiture superficiali che giocano con il senso del tatto e ricreano gli effetti della pietra, del cemento, del marmo. Qui la materia si plasma ai nostri desideri e si fa portatrice di stile, eleganza, carattere.

Shower tray collections by Nicos International was created with the aim of enhancing the senses. Every detail is designed to create harmony and integrate this element completely into the overall design. The skilful use of Mineralsolid allows surface finishes to be created that play on the sense of touch and recreate the effects of stone, concrete and marble. The material is moulded to our desires and becomes a champion of style, elegance and character.

cemento | concrete

MINERALSOLID® (opaco | matt)

codice
code

dimensioni
dimensions

piletta laterale | side drain hole

P|D 70-80-90-100
S|T 4

M07970A L|L 90
M07971A 100
M07968A 120
M07976A 140

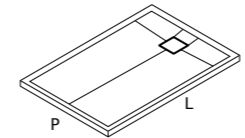

M07974A L|L 80
M07966A 100
M07962A 120
M07967A 140
M07972A 160

M07975A L|L 90
M07981A 100
M07969A 120
M07973A 140
M07979A 160

M07983A L|L 100
M07982A 120

piletta centrale | central drain hole

P|D 70-80-90
S|T 4

M07978A L|L 170

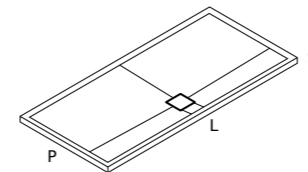

M07980A L|L 170
M07977A 180

M07985A L|L 170
M07984A 180

colori standard
standard colours



bianco
white

grigio
grey

installazione
installation

appoggio
on floor
semi-incasso
semi-recessed
incasso
recessed

certificazioni
certifications



indice | index →

← indice | index



edge (texture pietra | stone)

MINERALSOLID® (opaco | matt)

codice
code

dimensioni
dimensions

piletta laterale | side drain hole

PID 70-80-90-100
S|T 4

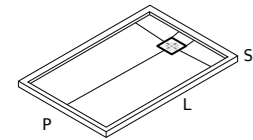

M08217A L|L 90
M08218A 100
M08219A 120
M08220A 140

M08221A L|L 80
M08222A 100
M08184A 120
M08223A 140
M08224A 160

M08225A L|L 90
M08226A 100
M08227A 120
M08228A 140
M08229A 160

M08230A L|L 100
M08231A 120

piletta centrale | central drain hole

PID 70-80-90
S|T 4

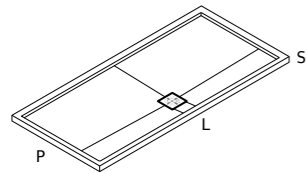

M08232A L|L 170

M08233A L|L 170
M08234A 180

M08235A L|L 170
M08236A 180

colori standard
standard colours



bianco white
tortora tortora
grigio grey
cenere ash
cappuccino cappuccino
nero black

← indice | index

installazione
installation

appoggio
on floor
semi-incasso
semi-recessed
incasso
recessed

certificazioni
certifications



indice | index →

ardesia | slate

MINERALSOLID® (opaco | matt)

codice
code

dimensioni
dimensions

piletta laterale | side drain hole

P|D 70-80-90-100
S|T 3

M08108A L|L 90
M08109A 100
M08106A 120
M08114A 140

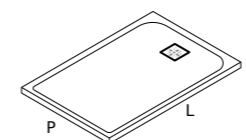

M08112A L|L 80
M08104A 100
M08103A 120
M08105A 140
M08110A 160

M08113A L|L 90
M08119A 100
M08107A 120
M08111A 140
M08117A 160

M08121A L|L 100
M08120A 120

piletta centrale | central drain hole

P|D 70-80-90
S|T 3

M08116A L|L 170

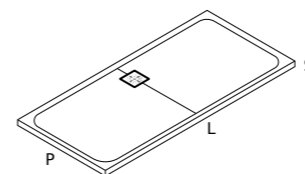

M08118A L|L 170
M08115A 180

M08123A L|L 170
M08122A 180

colori standard
standard colours



bianco
white

nero
black

installazione
installation

appoggio
on floor
semi-incasso
semi-recessed
incasso
recessed

certificazioni
certifications



indice | index →

← indice | index

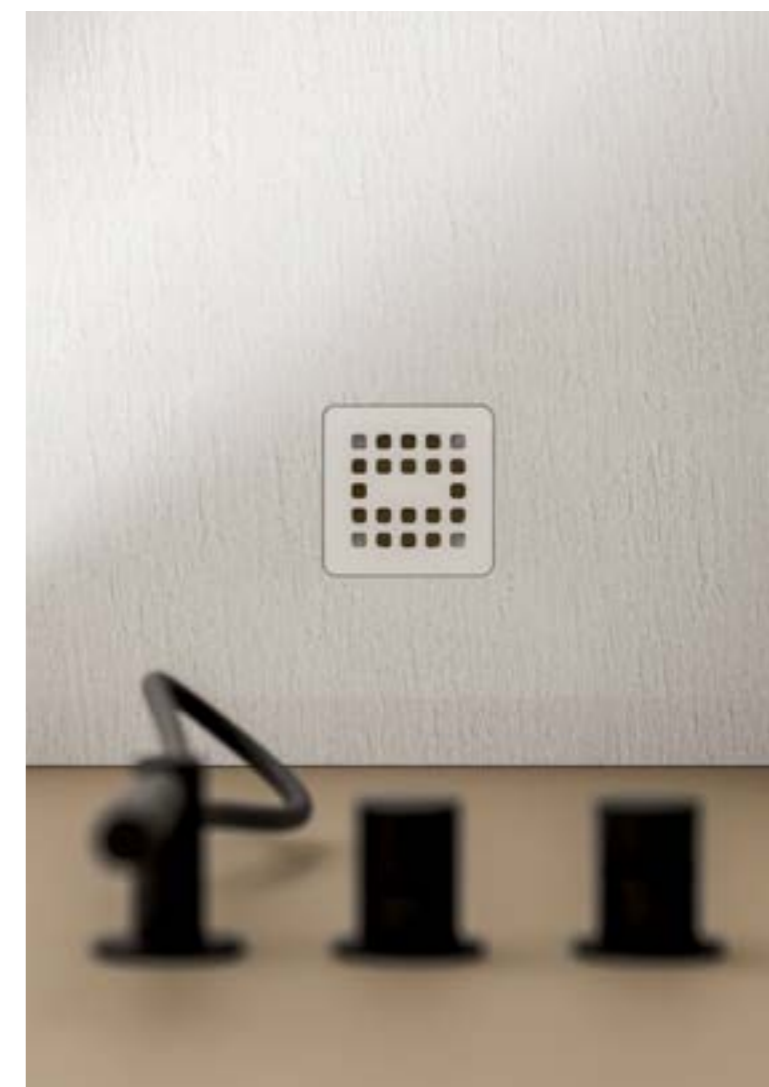

pietra | stone

MINERALSOLID® (opaco | matt)

codice
code

dimensioni
dimensions

piiletta laterale | side drain hole

P|D 70-80-90-100
S|T 3

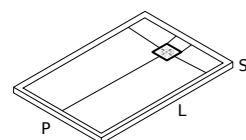

M07635A L|L 90
M07636A 100
M07637A 120
M07746A 140
M07929A 160

M07638A L|L 80
M07639A 100
M07640A 120
M07641A 140
M07854A 160

M07642A L|L 90
M07850A 100
M07643A 120
M07853A 140
M07855A 160

M07851A L|L 100
M07852A 120
M07911A 140
M07912A 160

angolare | corner

P|D 80-90-100
S|T 3

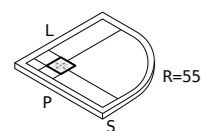

M07908A L|L 80

M07909A L|L 90

M07910A L|L 100

colori standard
standard colours



bianco white
tortora tortora
grigio grey
cenere ash
cappuccino cappuccino
nero black

← indice | index

codice
code

dimensioni
dimensions

piiletta centrale | central drain hole

P|D 70-80-90-100
S|T 3

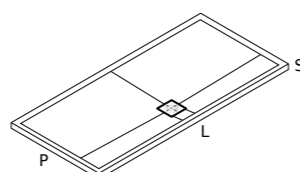

M07856A L|L 170
M07930A 180

M07948A L|L 180
M07859A 180

M07858A L|L 170
M07950A 180
M07860A 180

M07942A L|L 170
M07943A 180
M07961A 200

installazione
installation

appoggio
on floor
semi-incasso
semi-recessed
incasso
recessed

certificazioni
certifications



indice | index →

liscio | smooth

MINERALSOLID® (opaco | matt)

codice
code

dimensioni
dimensions

piletta laterale | side drain hole

P|D 70-80-90-100
S|T 3

M07624A L|L 90
M07625A 100
M07626A 120
M07745A 140

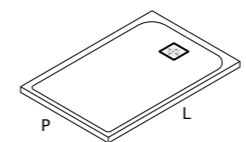

M07627A L|L 80
M07628A 100
M07566A 120
M07629A 140
M07947A 160

M07747A L|L 90
M07767A 100
M07601A 120
M07602A 140
M07949A 160

M07790A L|L 100
M07791A 120
M07792A 140
M07951A 160

angolare | corner

P|D 80-90-100
S|T 3

M07907A L|L 80

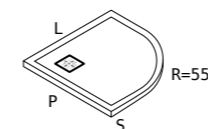

M07878A L|L 90

M07893A L|L 100

colori standard
standard colours



bianco
white

codice
code

dimensioni
dimensions

piletta centrale | central drain hole

P|D 70-80-90-100
S|T 3

M07946A L|L 170

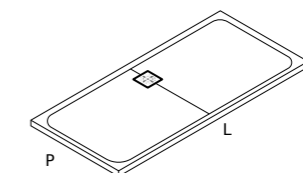

M07857A L|L 170

installazione
installation

appoggio
on floor
semi-incasso
semi-recessed
incasso
recessed

certificazioni
certifications



liscio piatto doccia a misura

smooth bespoke shower tray

MINERALSOLID® (opaco | matt)

codice
code

dimensioni
dimensions

piletta laterale | side drain hole

P|D 70
S|T 3

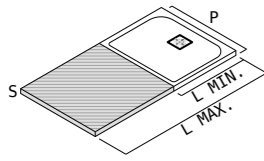

M07190A L min70 max140

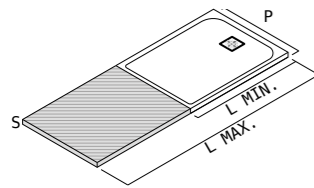

M07537A L min140 max250

P|D 90
S|T 3

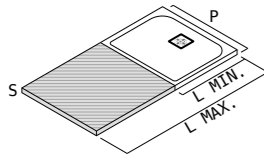

M07188A L min90 max140

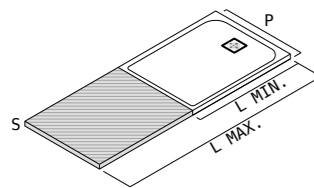

M07539A L min140 max250

colori standard
standard colours



bianco
white

← indice | index

codice
code

dimensioni
dimensions

piletta laterale | side drain hole

P|D 80
S|T 3

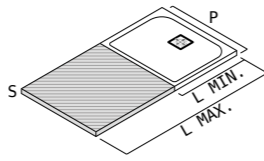

M07186A L min80 max140

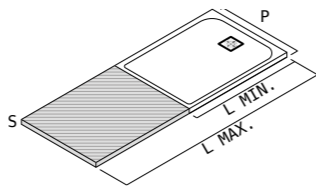

M07538A L min140 max250

P|D 100
S|T 3

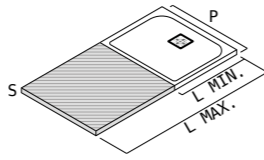

M07952A L min140 max250

piletta centrale | central drain hole

P|D 80÷90
S|T 3

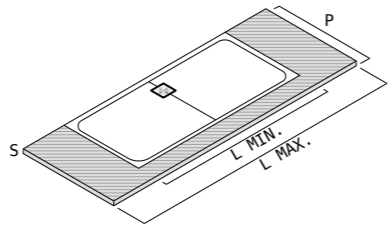

M07240A L min160 max250

installazione
installation

appoggio
on floor

semi-incasso
semi-recessed

incasso
recessed

certificazioni
certifications



indice | index →

pietra piatto doccia a misura

stone bespoke shower tray

MINERALSOLID® (opaco | matt)

codice
code

dimensioni
dimensions

piletta laterale | side drain hole

P|D 70
S|T 3

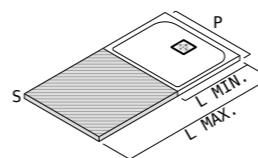

M07239A L min70 max140
M08048A L min90 max110
M08047A L min110 max140

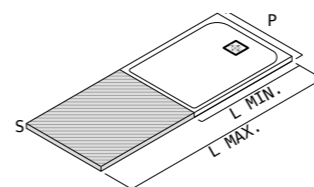

M07543A L min140 max250

P|D 90
S|T 3

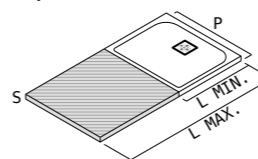

M07237A L min90 max140
M08049A L min110 max140

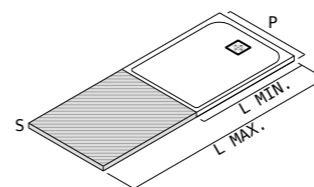

M07545A L min140 max250

colori standard
standard colours



bianco white
tortora tortora
grigio grey
cenere ash
cappuccino cappuccino
nero black

codice
code

dimensioni
dimensions

piletta laterale | side drain hole

P|D 80
S|T 3

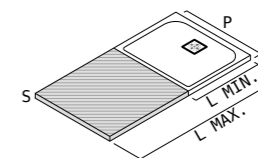

M07238A L min80 max140
M08046A L min90 max110
M08045A L min110 max140

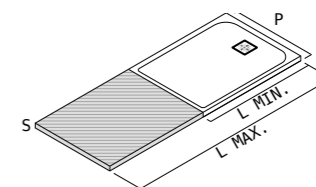

M07544A L min140 max250

P|D 100
S|T 3

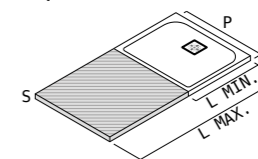

M07944A L min140 max250

piletta centrale | central drain hole

P|D 80÷90
S|T 3

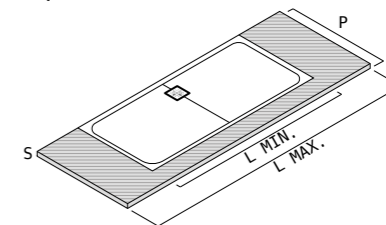

M07242A L min160 max250

installazione
installation

appoggio
on floor
semi-incasso
semi-recessed
incasso
recessed

certificazioni
certifications



indice | index →

178 materiali / materials

186 certificazioni / certifications

materiali. materials.

Due famiglie di materiali ecologici, riciclabili e virucidi.

Nei nostri laboratori la ricerca di nuove soluzioni è costante: formulazioni di resine sempre più performanti e green, trattamenti di cariche, sistemi innovativi di polimerizzazione e trattamento delle superfici. Il nostro team di ricerca collabora con università e laboratori esterni, per ottenere risultati sempre migliori, garantiti dalle più importanti certificazioni internazionali; la nostra produzione risponde alle attuali normative di settore - CE per l'Europa e C-UPC per il mercato NORD AMERICANO - e tutti i nostri materiali hanno il "Greenguard Gold Certificate" assegnato dall'americana UL. Nell'ultimo triennio tutti i nostri materiali sono stati potenziati e presentano caratteristiche antimicotiche, autopulenti e antibatteriche; dal 2020 presentano anche caratteristiche virucide per combattere la Sars-Cov-2.

Two families of ecological, recyclable and virucidal materials.

In our laboratories we develop different areas of research: formulations of ever more performing and green resins, treatments of fillers, innovative systems of polymerization and surface treatment.

Our chemists collaborate with universities and external laboratories, in order to obtain ever better results, guaranteed by the most important international certifications: our production meets current sector standards - CE for Europe and C-UPC for USA - while all our materials have the "Gold Certificate Greenguard" awarded by the American UL.

All our materials have been enhanced and present antifungal, self-cleaning and antibacterial characteristics; and also from 2020 virucidal characteristics to fight Sars-Cov-2.

vasche
baths

lavabi
washbasins

piatti doccia
shower trays



solid surface

solid®

Con il famoso effetto “soft touch” e una bellezza simile alla pietra naturale levigata, il nostro solid surface è composto da cariche minerali - principalmente triidrati di alluminio - legate a resine naturali Biobased® derivanti da coltivazioni di mais di origine controllata. Le esclusive formulazioni, messe a punto nei nostri laboratori, sono igieniche, setose, resistenti, stampabili, facilmente lavorabili. Il nostro core business è sempre stato l'arredo bagno - piatti doccia, vasche e lavabi - Negli anni questi materiali sono stati utilizzati anche dai più importanti marchi dell'arredamento di alta gamma per lo sviluppo di tavoli, pareti modulari e accessori.

The famous “soft touch” effect and beauty similar to polished natural stone, our solid surfaces comprise mineral fillers – mainly aluminium trihydrates – bound by natural Biobased® resins derived from corn of controlled origin. The exclusive formulations, created in our laboratories, are hygienic, silky, resistant, printable, easily workable and if necessary are used for cuts and punctures. Our core business has always been bathroom fittings – shower trays, baths and washbasins – although over the years these materials have been used by the most important brands of high-end furnishings such as tables, modular walls and accessories.



Triidrati di alluminio + resina biobased
Aluminium trihydrates + Biobased® resin

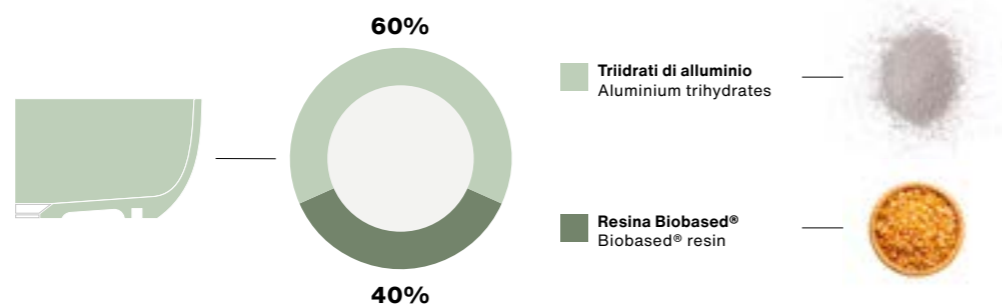

cast marble

mineralsolid®
mineralmarmo®

I nostri materiali in marmoresina sono disponibili in diverse finiture, sia opache che lucide. Questi materiali superano la ceramica viste le caratteristiche tecniche superiori e sono spesso richiesti al posto della ceramica tradizionale. Garantiscono una maggiore resistenza anche con uno spessore inferiore, oltre a raggiungere dimensioni impensabili per materiali come la ceramica, il vetro e l'acrilico. Le finiture lucide di alta qualità sono paragonabili al vetro, pur mantenendo prestazioni tecniche eccezionali. La flessibilità produttiva consente inoltre una variabilità cromatica e una ripetitività senza pari con tolleranze minime tra lotti di produzione diversi.

Our cast marble materials are available in multiple finishes, both matt and glossy. These materials out-perform ceramic with superior technical characteristics and are often specified in place of traditional ceramic. They guarantee greater resistance even with a lower thickness, in addition to achieving dimensions unthinkable for materials such as ceramic, glass and acrylic. The high-quality glossy finishes are comparable to glass, while maintaining exceptional technical performance. Production flexibility also allows for chromatic variability and unparalleled repetitiveness with minimum tolerances.

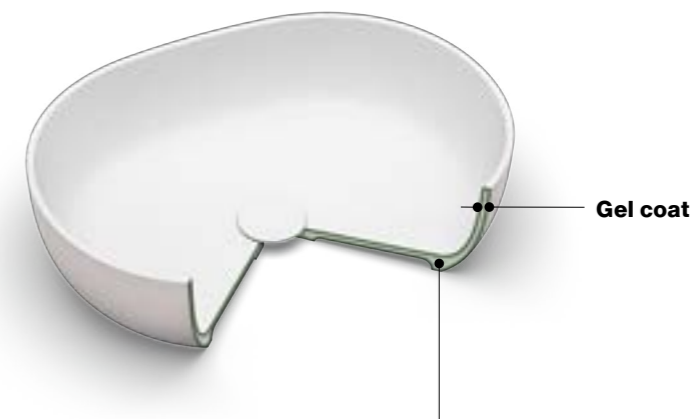

Dolomite + resina e resina PET riciclata
Dolomite + Resin and recycled PET resin

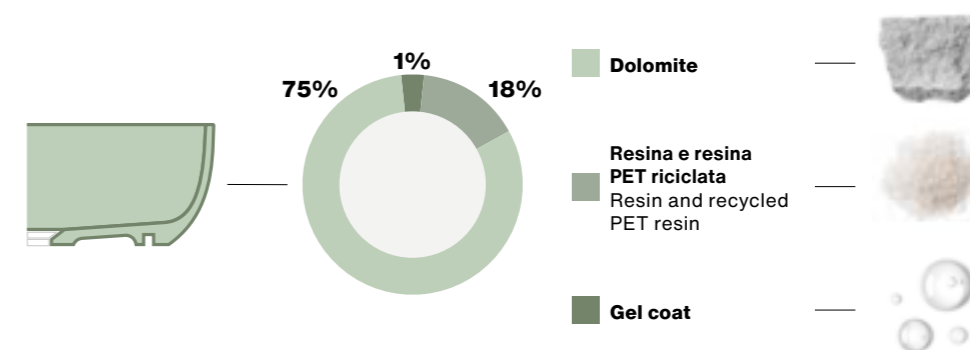

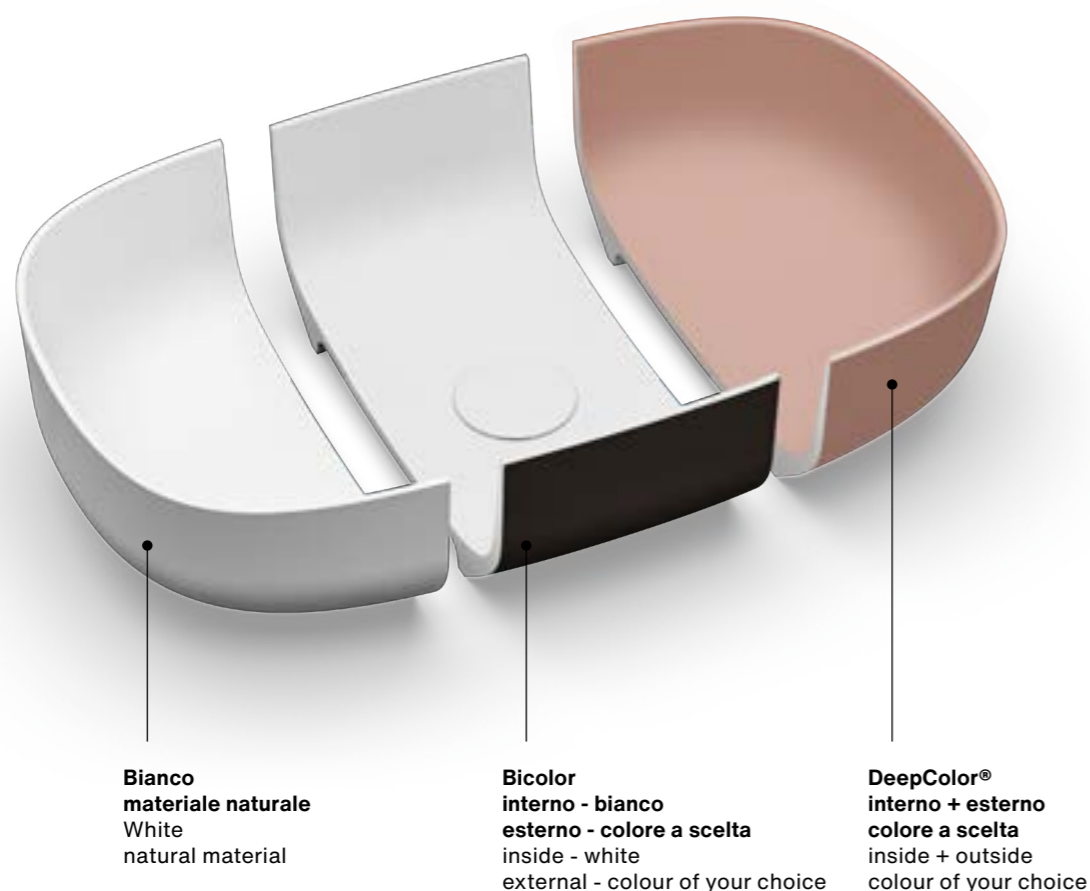

Bianco
materiale naturale
White
natural material

Bicolor
interno - bianco
esterno - colore a scelta
inside - white
external - colour of your choice

DeepColor®
interno + esterno
colore a scelta
inside + outside
colour of your choice

bianco opaco | white matt

DESCRIZIONE

È un materiale composito realizzato con 2/3 di idrati di alluminio, mescolati magistralmente con resine poliestere modificate con monomeri acrilici dalle alte prestazioni chimico-fisiche. Tutto questo porta ad avere un materiale omogeneo e uniforme in tutto lo spessore, grazie anche all'attenta procedura di realizzazione industriale che può, per certi versi, definirsi ancora artigianale, data la scrupolosità impiegata e la minuziosa attenzione per i particolari. Le principali caratteristiche di questo prodotto sono la compattezza, la resistenza agli agenti chimici e solventi e la resistenza al graffio; inoltre, data l'uniformità in tutto lo spessore, eventuali danneggiamenti possono essere facilmente rimossi utilizzando una spugnetta abrasiva per rinnovare così la superficie.

DESCRIPTION

A composite material made up of 2/3 aluminium hydrates, masterfully blended with polyester resins modified with chemical and mechanical high-performance acrylic monomers. All this yields a material that is homogeneous and uniform throughout its thickness, thanks to an extremely accurate industrial production process that may be, in some ways, still be defined as craft for its thoroughness and meticulous attention to detail. The main characteristics of this product are its compactness, resistance to chemical agents and/or solvents and scratch resistance. Moreover, being uniform throughout its thickness, any kind of damage can be easily removed by rubbing the surface with a scouring sponge to renew the surface.

Bicolor ● opaco | matt

DESCRIZIONE

Per tutti i clienti che non vogliono rinunciare ad un tocco di colore in bagno, abbiamo la possibilità di verniciare solo la superficie eterna dei nostri prodotti... un tocco di classe abbinato alla morbidezza del solid surface.

DESCRIPTION

For all those customers who don't want to give up a touch of color in the bathroom, we have the possibility of painting only the external faces of our products... a touch of color combined with the softness of solid surface.

Deepcolor ● opaco | matt



DESCRIZIONE

DeepColor è una verniciatura a finire bicomponente acrilico-poliuretano e pigmenti. La natura alifatica delle resine conferisce resistenza all'ingiallimento nel tempo, mentre la componente acrilica garantisce resistenza alle sollecitazioni termiche per l'uso nel bagno domestico. L'applicazione con vernice a spruzzo dona al prodotto un aspetto sartoriale unico, all'avanguardia, moderno ed una colorazione compatta e uniforme. DeepColor è applicabile a tutti gli articoli: lavabi e vasche, nei materiali Cristalplant® e Mineralmarmo®. La verniciatura è adatta a tutte le superfici, piane e curve e anche nelle parti soggette a contatto con l'acqua.

Le caratteristiche principali sono:

- Gradevolezza estetica
- Uniformità del colore
- Vasta gamma colori
- Ottima adesione
- Ottima impermeabilità superficiale
- Resistenza allo shock termico
- Resistenza ai raggi UV
- Facilità di pulizia
- Buona resistenza alle macchie
- Buona resistenza agli urti

DeepColor è disponibile in una vasta gamma colori in finitura opaca e lucida:

- 1950 tinte NCS INDEX
- 213 RAL K5 Classic (escluso metallizzati)

DESCRIPTION

DeepColor is a two-component acrylic-polyurethane and pigment finish paint. The aliphatic nature of the resins gives resistance to yellowing over time, while the acrylic component guarantees resistance to thermal stress for use in the domestic bathroom. The application with spray paint gives the product a technical, modern appearance and a compact and uniform color.

DeepColor can be applied to all items: washbasins and bathtubs, in Cristalplant® and Mineralmarmo® materials. The painting is suitable for all surfaces, flat and curved and also in parts subject to contact with water.

The main features are:

- Aesthetic pleasantness
- Color uniformity
- Wide range of colors
- Excellent adhesion
- Excellent surface impermeability
- Resistance to thermal shock
- UV resistance
- Easy to clean
- Good stain resistance
- Good impact resistance

DeepColor is available in a wide range of colors in matte and glossy finishes:

- 1950 NCS INDEX shades
- 213 RAL K5 Classic (excluding metallics)

mineralsolid®

bianco opaco | white matt

DESCRIZIONE

MINERALSOLID® è un materiale composito formato da cariche minerali naturali e resina. È rivestito da uno smalto tecnico ad affetto estetico opaco. Questo rivestimento (800 - 1000 µm) abbina ottime caratteristiche di resistenza a completa ripristinabilità della superficie.

DESCRIPTION

MINERALSOLID® is composed of natural mineral charges and resin. It is coated with a technical enamel that gives it an opaque finish. This coating (800 - 1000 µm) combines excellent resistance to full recoverability of the surface.

mineralmarmo®

bianco lucido | white glossy

DESCRIZIONE

MineralMarmo®, è un materiale composto da cariche minerali naturali (carbonati di calcio e triidrata di alluminio) e resina poliesteri. Lo smalto tecnico lucido che riveste la superficie del materiale è di tipo poliesteri acrilato, caratterizzato da ottime proprietà. L'estetica e le caratteristiche meccaniche e chimiche rendono questo materiale adatto all'arredo di bagno. MineralMarmo® è un materiale molto versatile che permette lo sviluppo di molte forme: lavandini con sottosquadra, lavandini a misura, piani, basamenti, colonnine.

DESCRIPTION

MineralMarmo® is composed of natural mineral charges (calcium carbonate and aluminium trihydrates) and polyester resin. The glossy technical enamel covering the material surface is of the polyester acrylate type of excellent properties. The aesthetic, mechanical and chemical properties make this material suitable for bathroom furniture applications. MineralMarmo® is a very versatile, lightweight material, which makes it possible to manufacture a wide range of object shapes: undercut washbasins, customized washbasins, base elements, columns.

certificazioni certifications

La nostra azienda, i nostri materiali e tutti i nostri prodotti sono costantemente sottoposti a controlli da parte dei più importanti enti certificatori mondiali, per garantire sempre la migliore qualità ovunque.

Our company, its materials and all our products are constantly subjected to checks by the most important certifying agencies, to guarantee the best quality all over the world.

Made in Italy

ISO 9001:2015



VASCHE BATHTUBS

- Marcatura CE
- Dop-Dichiarazione di presentazione
- GREENGUARD Gold - Certificato di conformità
- ECV-Validazione della dichiarazione di contenuti bio nelle formulazioni
- ECV-Validazione delle dichiarazioni di contenuti bio nelle formulazioni da fonti rinnovabili
- EPD-Dichiarazione ambientale di prodotto

- CE marking
- Dop declaration of performance
- GREENGUARD Gold
- ECV-raw material of plant origin
- ECV-raw material from renewable sources
- EPD

LAVABI WASHBASINS

- Marcatura CE
- Dop - Dichiarazione di presentazione
- GREENGUARD Gold - Certificato di conformità
- ECV-Validazione della dichiarazione di contenuti bio nelle formulazioni
- ECV-Validazione delle dichiarazioni di contenuti bio nelle formulazioni da fonti rinnovabili
- EPD-Dichiarazione ambientale di prodotto

- CE marking
- Dop declaration of performance
- GREENGUARD
- ECV-raw material of plant origin
- ECV-raw material from renewable sources
- EPD

PIATTI DOCCIA SHOWER TRAYS

- Marcatura CE
- Dop-Dichiarazione di presentazione
- GREENGUARD Gold - Certificato di conformità
- EPD-Dichiarazione ambientale di prodotto

- CE marking
- Dop declaration of performance
- GREENGUARD Gold
- EPD

CE marking



La marcatura CE fa riferimento al Regolamento Europeo 305/2011 per i prodotti da costruzione. Questo regolamento stabilisce i criteri di tracciabilità e conformità delle diverse categorie di prodotti da costruzione.

Vasche, lavabi, piatti doccia devono soddisfare specifici requisiti tecnici sia progettuali che prestazionali, essere corredati da una Dichiarazione di Prestazione (DoP) ed essere etichettati CE.

A seguito della Brexit, per Gran Bretagna ed Irlanda del Nord i prodotti devono essere marcati UKCA.

The CE marking refers to the European Regulation 305/2011 for construction products. This regulation establishes the traceability and conformity criteria for the different categories of construction products.

Bathtubs, sinks, shower trays must meet specific technical requirements, both in terms of design and performance, be accompanied by a Declaration of Performance (DoP) and be CE labeled.

Following Brexit, for Great Britain and Northern Ireland the products must be marked UKCA.

C-UPC certification



Per esportare prodotti sanitari in Nord America, la certificazione C-UPC è obbligatoria. Designato come standard nazionale americano, l'Uniform Plumbing Code (UPC) è un codice modello sviluppato dall'International Association of Plumbing and Mechanical Officials (IAPMO) per disciplinare l'installazione e l'ispezione degli impianti idraulici come mezzo per promuovere la salute, la sicurezza e il benessere degli utilizzatori. L'UPC è stato progettato per fornire ai consumatori impianti idraulici sicuri e igienici e, allo stesso tempo, per lasciare spazio all'innovazione e alle nuove tecnologie. Tutti i prodotti Nicos International sono certificati C-UPC.

To export sanitary ware products to North America, the certification C-UPC is mandatory. Designated as an American National Standard, the Uniform Plumbing Code (UPC) is a model code developed by the International Association of Plumbing and Mechanical Officials (IAPMO) to govern the installation and inspection of plumbing systems as a means of promoting health, safety and welfare. The UPC is designed to provide consumers with safe and sanitary plumbing systems while, at the same time, allowing latitude for innovation and new technologies. All Nicos products are C-UPC certified.

UL GREENGUARD certification



La maggior parte dell'esposizione quotidiana alle sostanze chimiche avviene attraverso l'aria che respiriamo nelle nostre case, uffici, scuole e altri ambienti interni. Queste sostanze sono comunemente riferite alla sigla COV (composti organici volatili). I prodotti che utilizziamo per costruire e arredare i nostri ambienti interni possono avere un impatto significativo sui livelli di inquinamento dell'aria interna. I prodotti che hanno ottenuto la certificazione GREENGUARD sono analiticamente testati per soddisfare alcuni degli standard più rigorosi al mondo in materia di COV, contribuendo a ridurre l'inquinamento dell'aria interna agli ambienti e il rischio di esposizione a sostanze nocive, favorendo al contempo la creazione di ambienti interni più salubri.

The majority of everyday chemical exposure in people occurs through the air we breathe in our homes, offices, schools and other indoor environments. These airborne chemicals are commonly referred to as volatile organic compounds (VOCs). The products we use to build and furnish our indoor environments can have a significant impact on indoor air pollution levels. Products that have achieved GREENGUARD Certification are scientifically proven to meet some of the world's most rigorous, third-party chemical emissions standards, helping to reduce indoor air pollution and the risk of chemical exposure, while aiding in the creation of healthier indoor environments.

nicos international

via Bastie, 44
31040 Portobuffolè (TV) – Italy

+39 0422 504411

info@nicosinternational.it

www.nicosinternational.it

I disegni, le dimensioni, i materiali e i colori del presente catalogo sono puramente indicativi. L'azienda si riserva il diritto di modificare i modelli in qualsiasi momento e senza preavviso.

Drawings, dimensions, materials and colours in this catalogue are indicative only. The Company reserves the right to modify the models at any time without prior notice.

©nicos - 2024

3D render
In-edito studio

styling
Lisa De Chirico

graphic
Luca Busetto

print
Solution

nicos international

www.nicosinternational.it